

# **3D Parallel FEM (I)**

## **Fortran**

Kengo Nakajima  
RIKEN R-CCS

# Target Application

- Parallel version of “heat3d”
- Using MPI

- Installation
- Execution
  - Procedures of Parallel FEM
  - Domain Decomposition/Partitioning
  - Real Execution
- Data Structure

# Preparation (Odyssey)

## FORTRAN

```
>$ cd /work/gt18/t18XYZ/pFEM
>$ cp /work/gt00/z30088/pFEM/F/fem3d.tar .
>$ tar xvf fem3d.tar
```

## C

```
>$ cd /work/gt18/t18XYZ/pFEM
>$ cp /work/gt00/z30088/pFEM/C/fem3d.tar .
>$ tar xvf fem3d.tar
```

## Confirmation

```
>$ ls
  mpi  fem3d  pfem3d
>$ cd pfem3d
```

# Compilation (Odyssey)

## Mesh Generator

```
>$ cd /work/gt18/t18XXX/pFEM/pfem3d/mesh  
>$ module load fj  
>$ frtpx -Kfast mgcube.f -o mgcube
```

## Domain Partitioner

```
>$ cd ../part  
>$ module load metis/4.0.3  
>$ make  
>$ ls ../mesh/part  
part
```

## Parallel FEM

```
>$ cd ../src  
>$ make  
>$ ls ../run/sol  
sol
```

- Installation
- **Execution**
  - **Procedures of Parallel FEM**
  - **Domain Decomposition/Partitioning**
  - **Real Execution**
- Data Structure

# Procedures for Parallel FEM

- Initial Global Mesh File
  - `/work/gt18/t18XYZ/pFEM/pfem3d/mesh/mg.sh`
- Distributed Local Mesh Files (Domain Partitioning)
  - `/work/gt18/t18XYZ/pFEM/pfem3d/mesh/part_XXX.sh`
- Parallel FEM Computation
  - `/work/gt18/t18XYZ/pFEM/pfem3d/run/XYZ.sh`

# Procedures for Parallel FEM

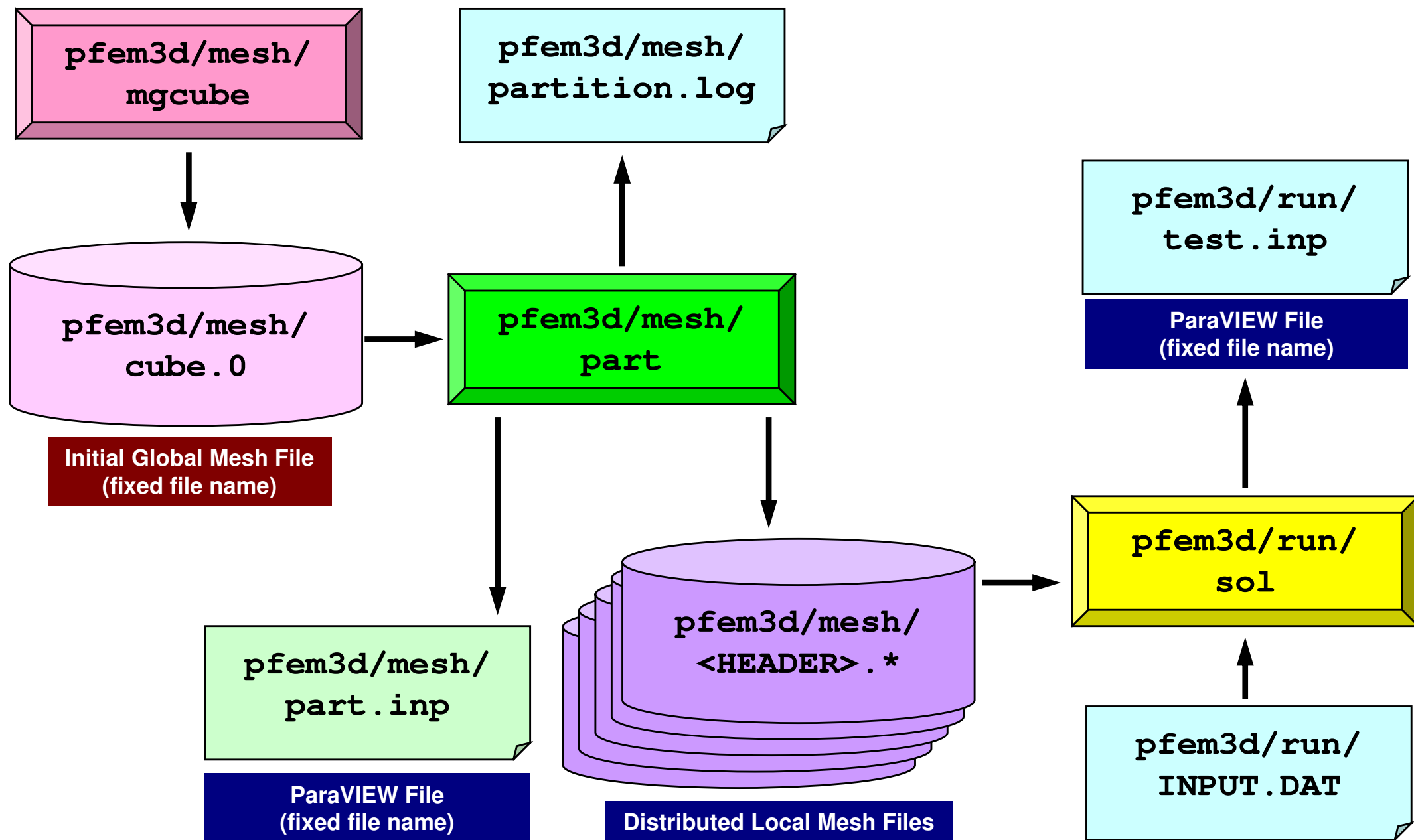



- Installation
- Execution
  - Procedures of Parallel FEM
  - **Domain Decomposition/Partitioning**
  - Real Execution
- Data Structure

# Partitioner

creates distributed local mesh files from  
initial global mesh **automatically**

1D code: in parallel FEM program, 3D: too complicated

- Internal/External Points
  - Distributed Local Mesh Files
  - Numbering: Internal -> External pts.
- Communication Tables
  - Neighbors
    - Number of Neighbors
    - ID's of Neighbors
  - External Points
    - From where, how many, and which external points are received/imported ?
  - Boundary Points
    - To where, how many and which boundary points are sent/exported ?

# What is Partitioning ?

- Graph/Graphic Partitioning
- Procedures/Operations of Domain Decomposition/Partitioning for Parallel Computing
- Creating Distributed Local Meshes from Huge Global Mesh which cannot be handled by a single PE

# What is Graph/Graphic Partitioning

“Graph/Graphic Partitioning”: Application of “Graph Theory” for *graphs* (set of vertices and edges) to domain partitioning in parallel computing

- one-stroke sketch
- 4-color problem

Good Partitioning

Load Balancing

Small Communications

Convergence of Preconditioned Iterative Solvers

Minimum # of Neighbors

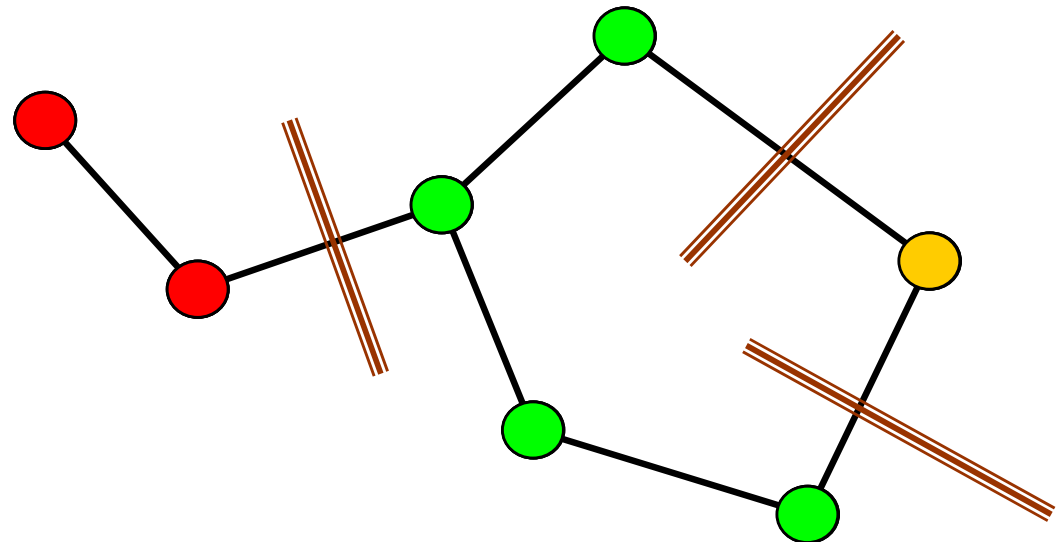

# What is Edge-Cut ?

- If each of vertices of the edge belongs to different PE (domain, partition), “edge-cut” occurs
- Smaller number of edge-cut’s, smaller communications

No EDGE-CUT

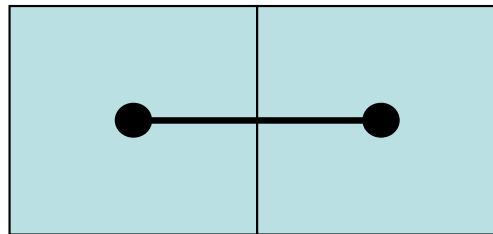

EDGE-CUT

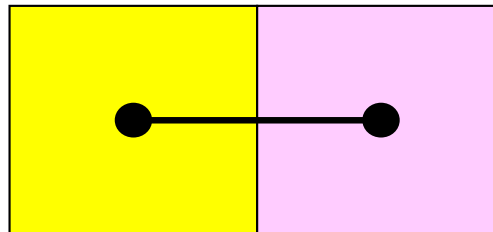

# Effect of Partitioning on Convergence

16 PE's for 2D ( $15 \times 15$ ) : Load Balanced

Many Edge-Cut's

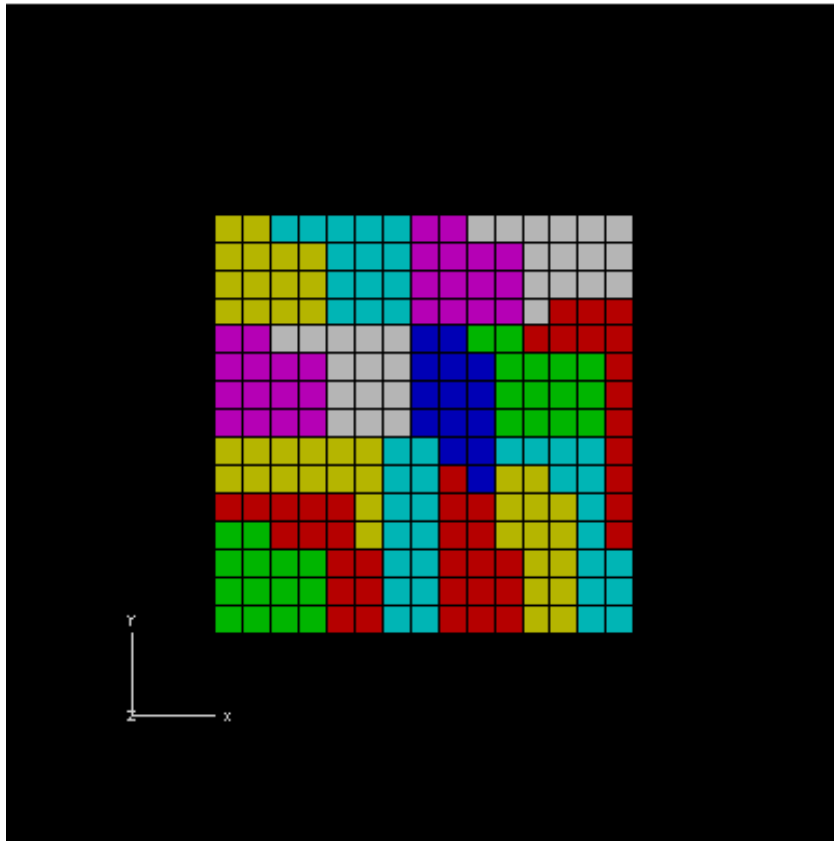

**RGB**

**Recursive Graph Bisection**

Fewer Edge-Cut's

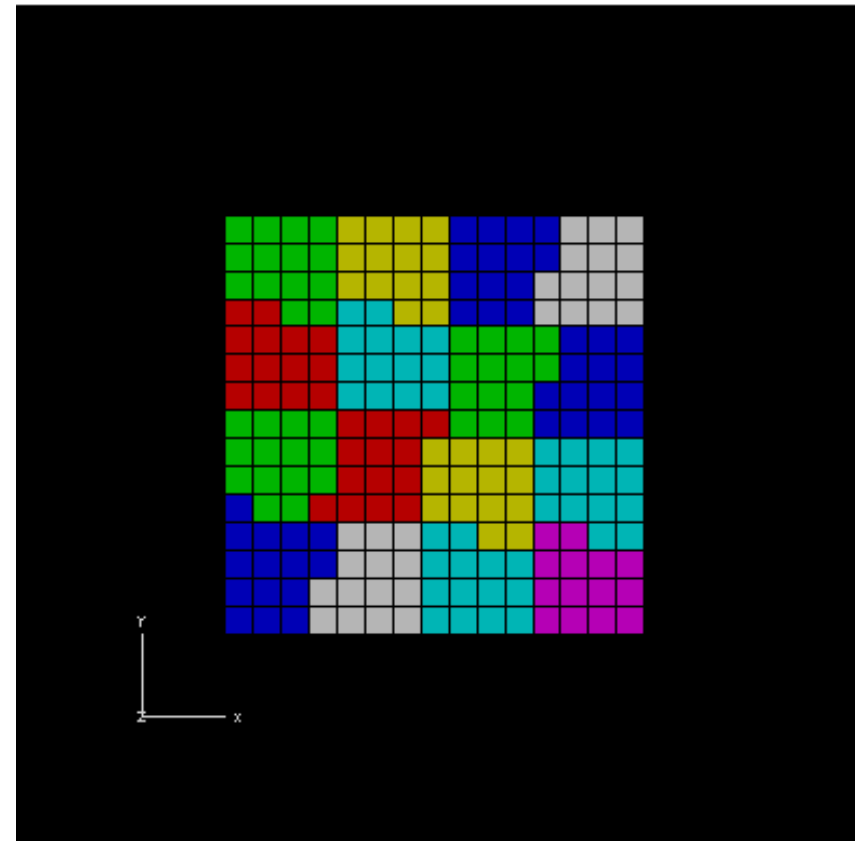

**RSB**

**Recursive Spectral Bisection**

# Effect of Partitioning on Convergence

BiCGSTAB with Localized ILU(0) Preconditioning  
 15X15 region, RGB/RSB for 16 PE's , Poisson eqn's  
 Fewer "edge-cut's" (smaller comm.), faster convergence

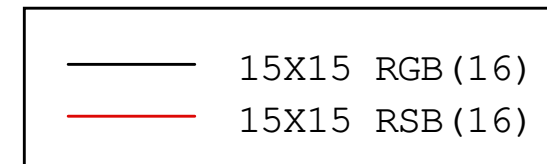
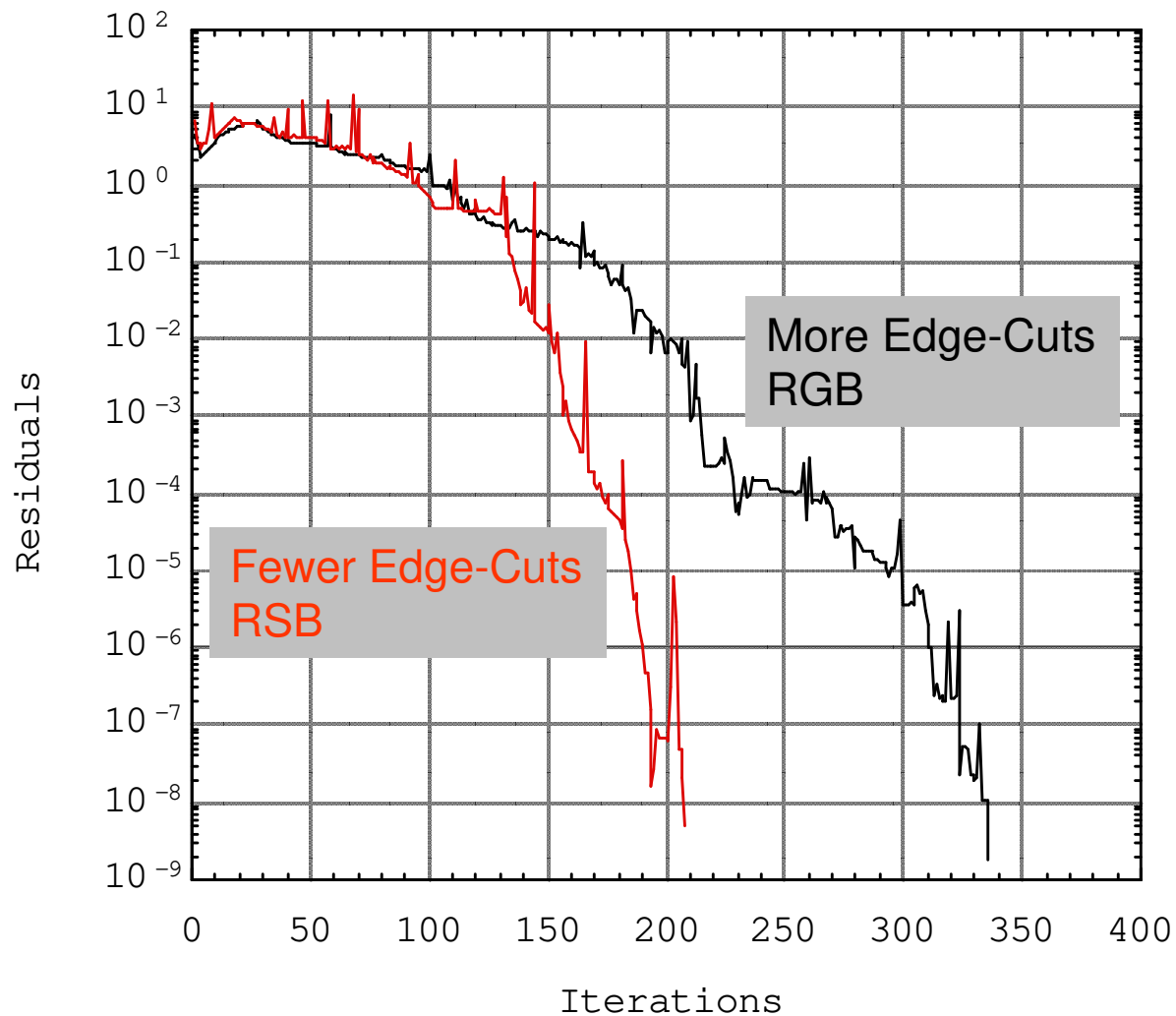

	<b>RGB</b>	<b>RSB</b>
Neighboring PEs (Ave., max)	3.63, 7	3.63, 6
Boundary Edges (Ave, max)	<b>15.1, 19</b>	<b>12.5, 18</b>

Done in February 1996

# Methods for Partitioning

- Many research groups in late 1990's, but currently **MeTiS** and **Scotch/PT-Scotch** are two major tools.
- **MeTiS**: Univ. Minnesota
  - <http://glaros.dtc.umn.edu/gkhome/views/metis/>
- **Scotch/PT-Scotch**: developed recently
  - <http://www.labri.fr/perso/pelegrin/scotch/>
- **JOSTLE**: Univ. Greenwich
  - <http://staffweb.cms.gre.ac.uk/~c.walshaw/jostle/>



# pFEM/pfem3d/mesh/part

- Tool which partitions initial global mesh file.
  - serial operation
- And creates distributed local mesh files with communication tables.
- Methods for Partitioning
  - RCB (Recursive Coordinate Bisection)
  - METIS
    - kmetis            Minimum edge-cut's
    - pmetis            Optimum load balancing

# Actual Large-Scale Computations

- Sometimes, it is difficult to prepare “initial global mesh”
- Starting from “coarse” initial mesh -> partitioning -> AMR (adaptive mesh refinement)

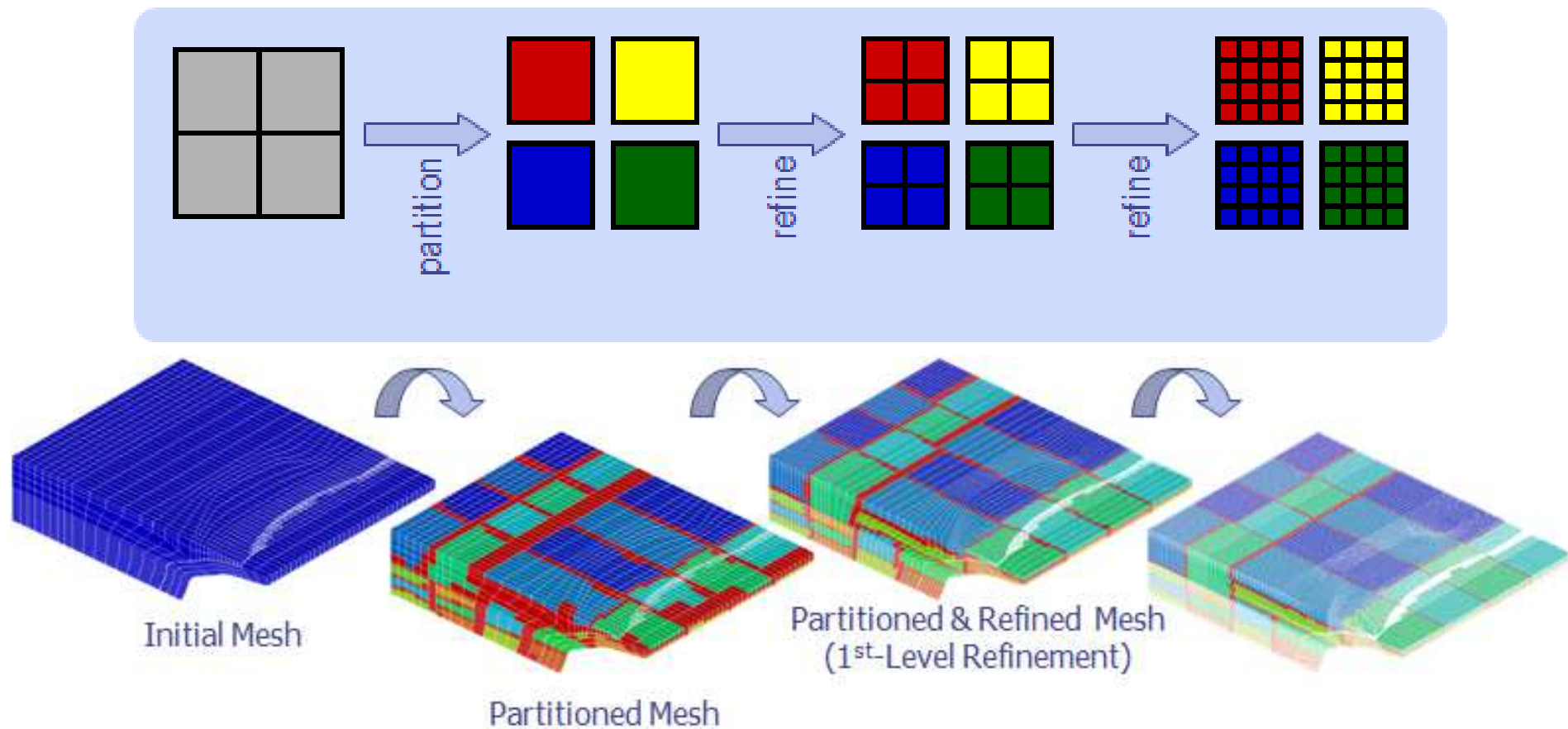

# RCB: Recursive Coordinate Bisection

H.D.Simon "Partitioning of unstructured problems for parallel processing", *Comp. Sys. in Eng.*, Vol.2, 1991.

- Comparing X-Y-Z components
- Reference axis can be selected according to the geometry
- Continuous partitioning along X-axis for slender objects
- Only  $2^n$  PE's
- Faster than **METIS** for simple geometry

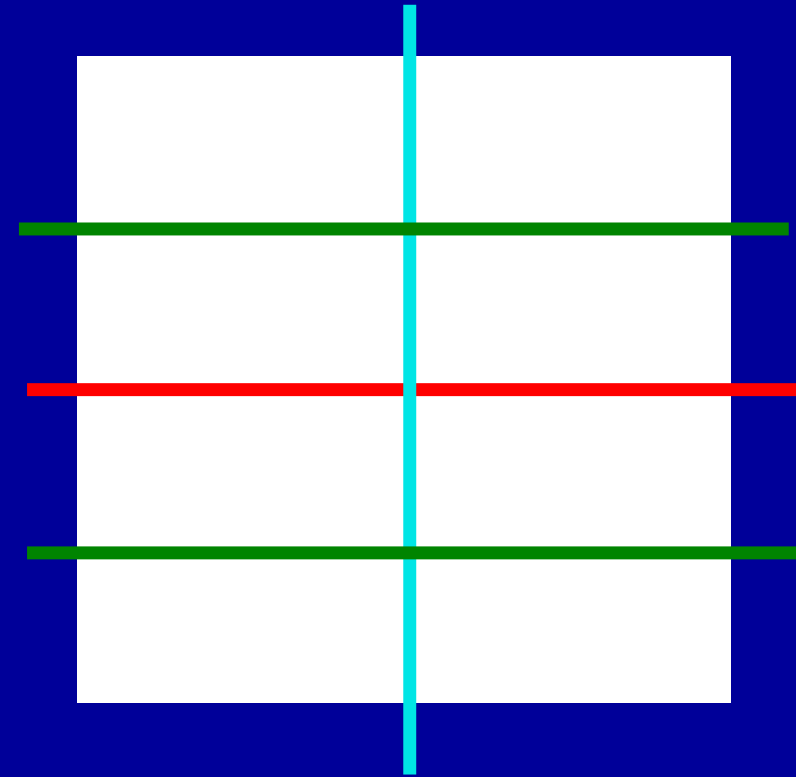

# METIS

<http://glaros.dtc.umn.edu/gkhome/views/metis/>

- based on Multi-Level Graph Theory

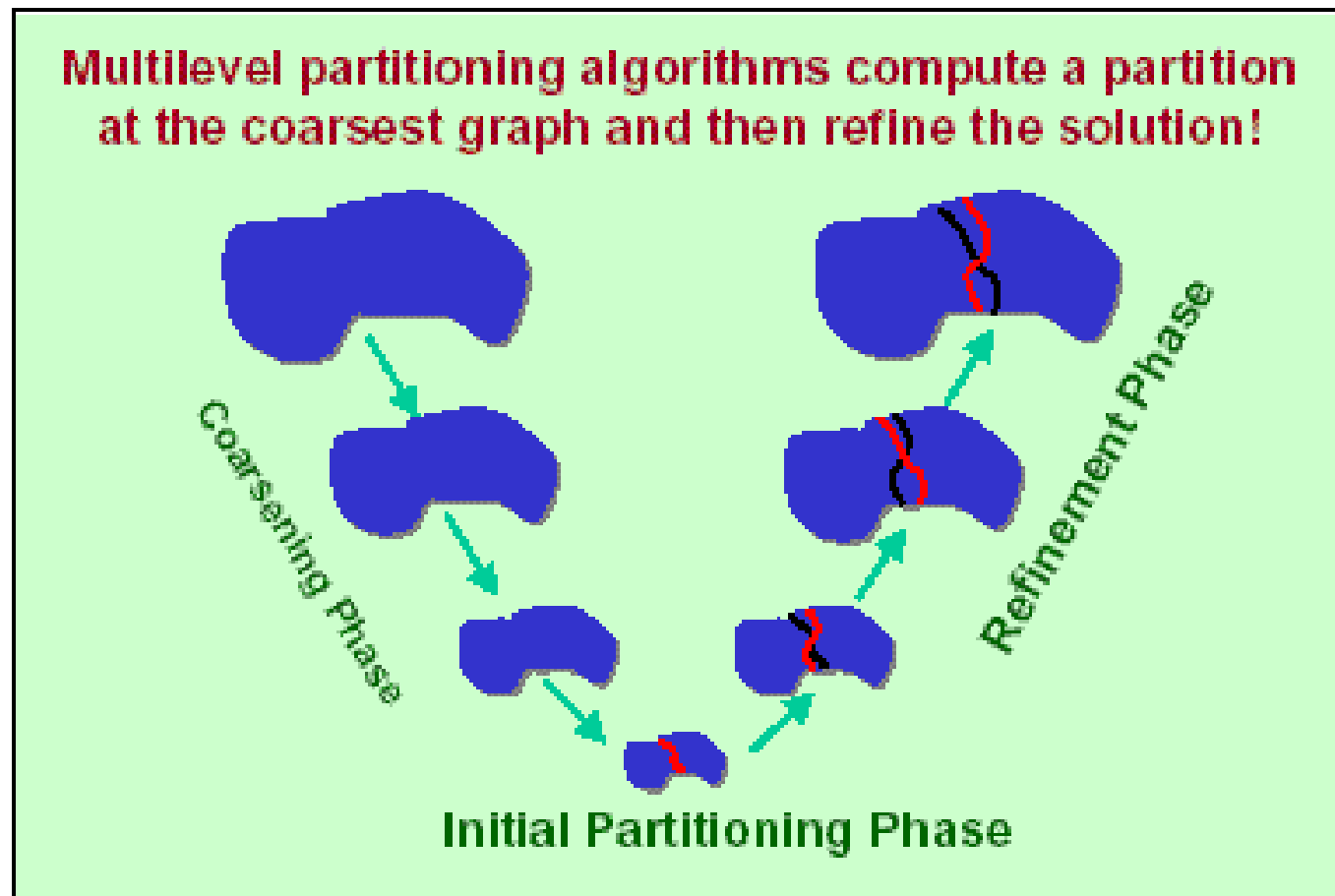

# METIS

<http://glaros.dtc.umn.edu/gkhome/views/metis/>

- based on Multi-Level Graph Theory
  - minimize edge-cut's (communications)
  - stable, fast
  - free, both stand-alone and library versions
- Various Procedures
  - k-METIS      Minimum Edge-Cut's
  - p-METIS      Optimum Load Balancing
  - ParMETIS     Parallel Version
  - applied to ordering, data-mining etc.
    - parallel contact search for crash problems

# Example: Cubes: 8 PEs

3,375 elements ( $=15^3$ ), 4,096 nodes

RCB is good for simple geometries

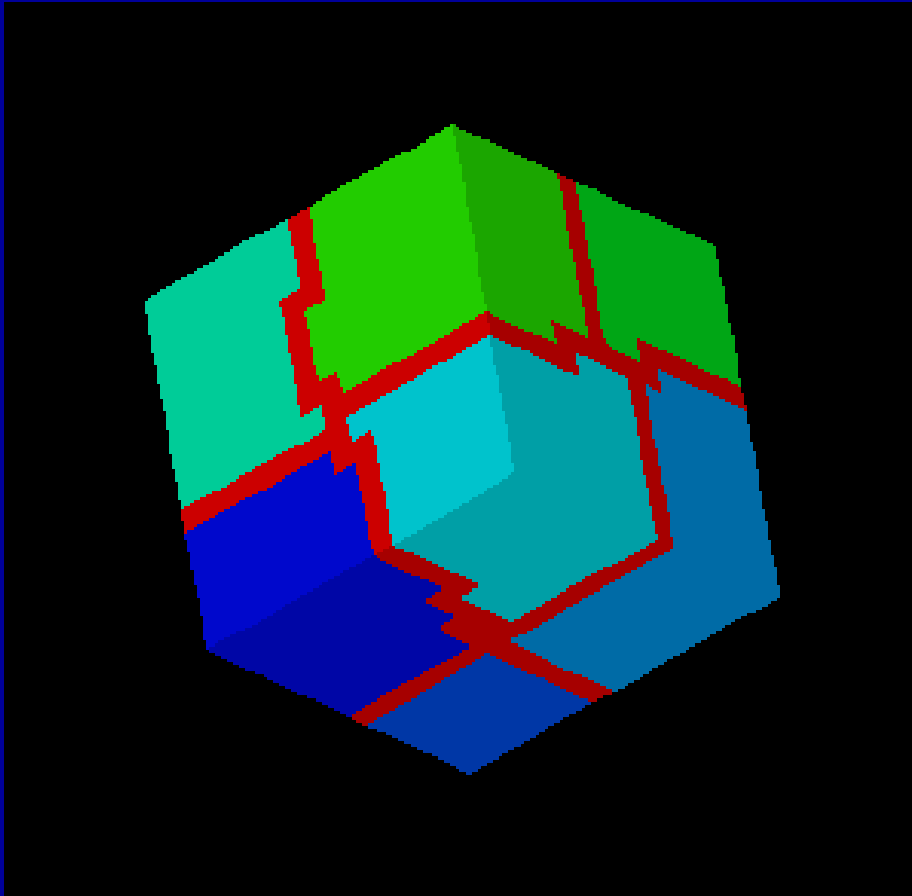

**k-METIS**  
edgecut = 882

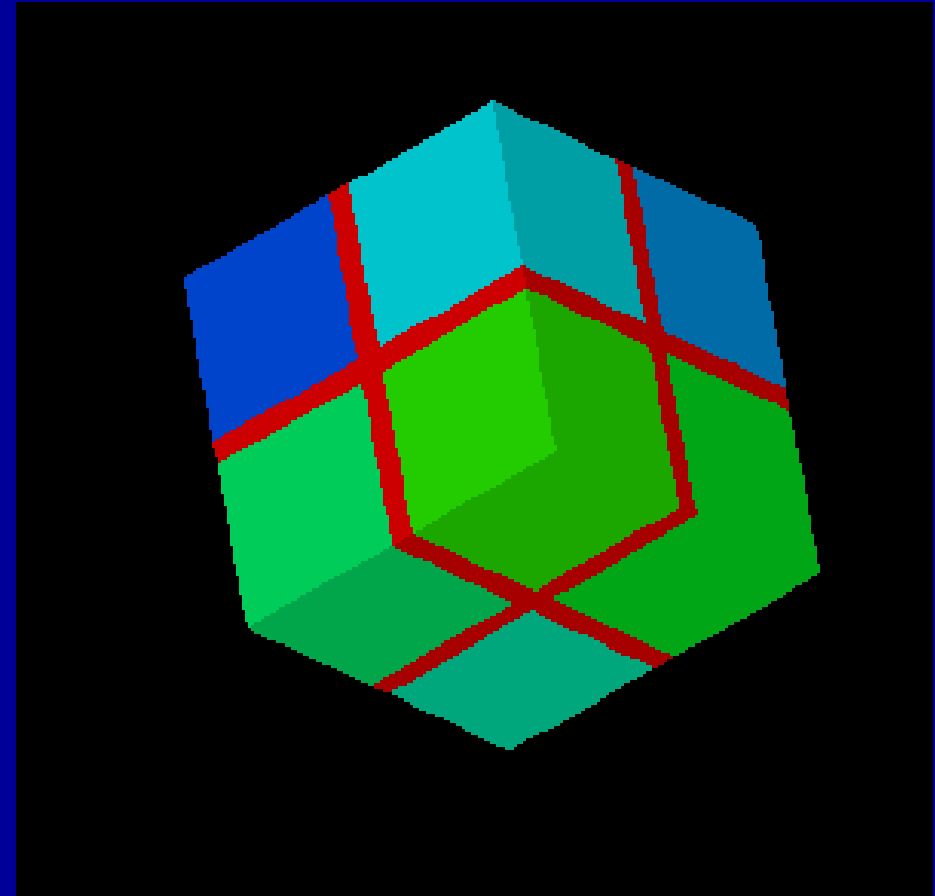

**RCB**  
edgecut = 768

# Example: Graphite Block: 8 PEs

795 elements, 1,308 nodes

MeTIS is better for complicated geometries

Overlapping zones are thin

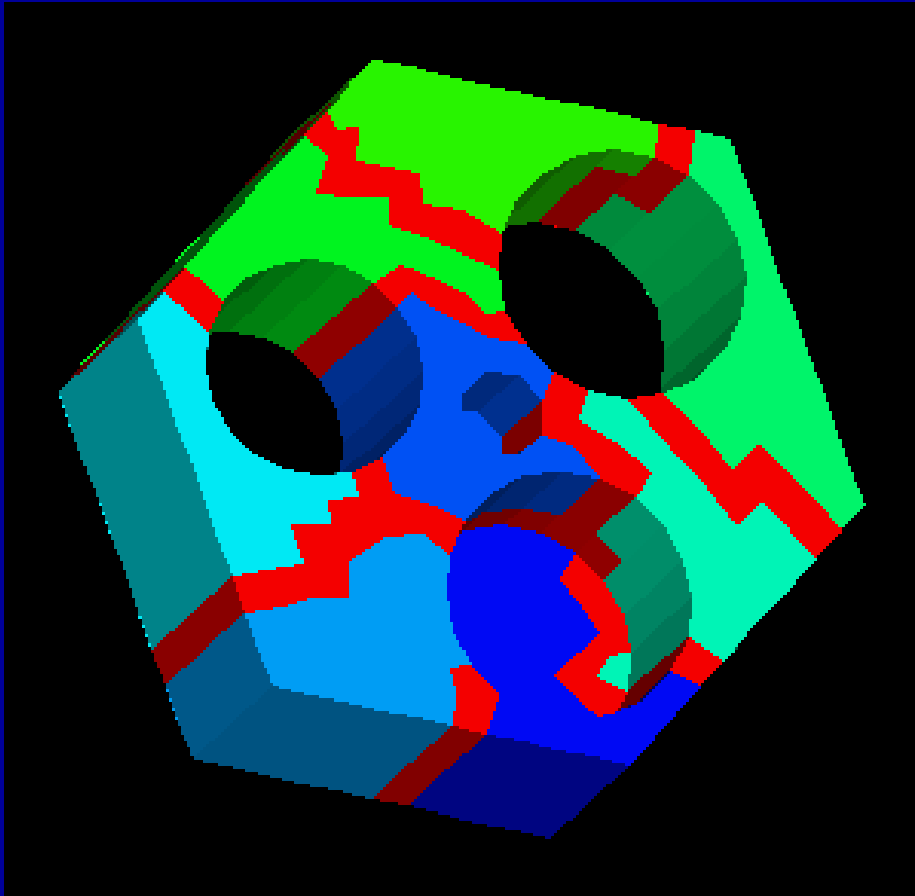

**k-MeTIS**

edgecut = 307

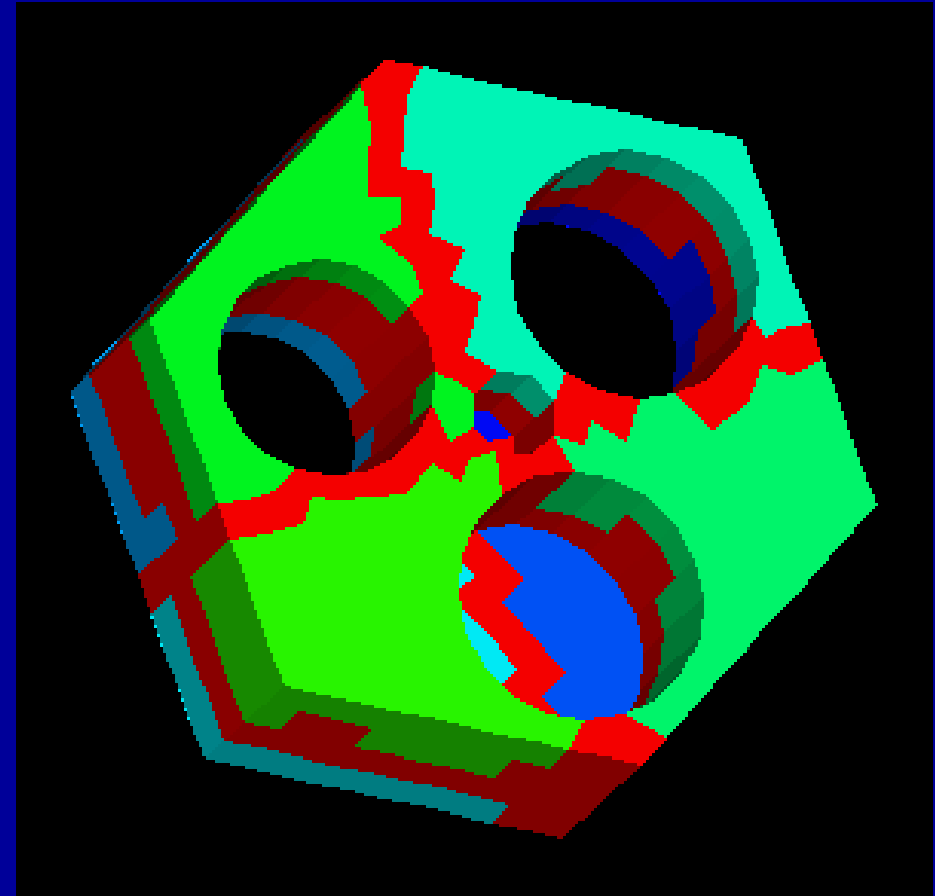

**RCB**

edgecut = 614

# Example: Tube Sheet: 64 PEs

40,416 elements, 54,084 nodes

MeTiS is better for complicated geometries

Overlapping zones are thin

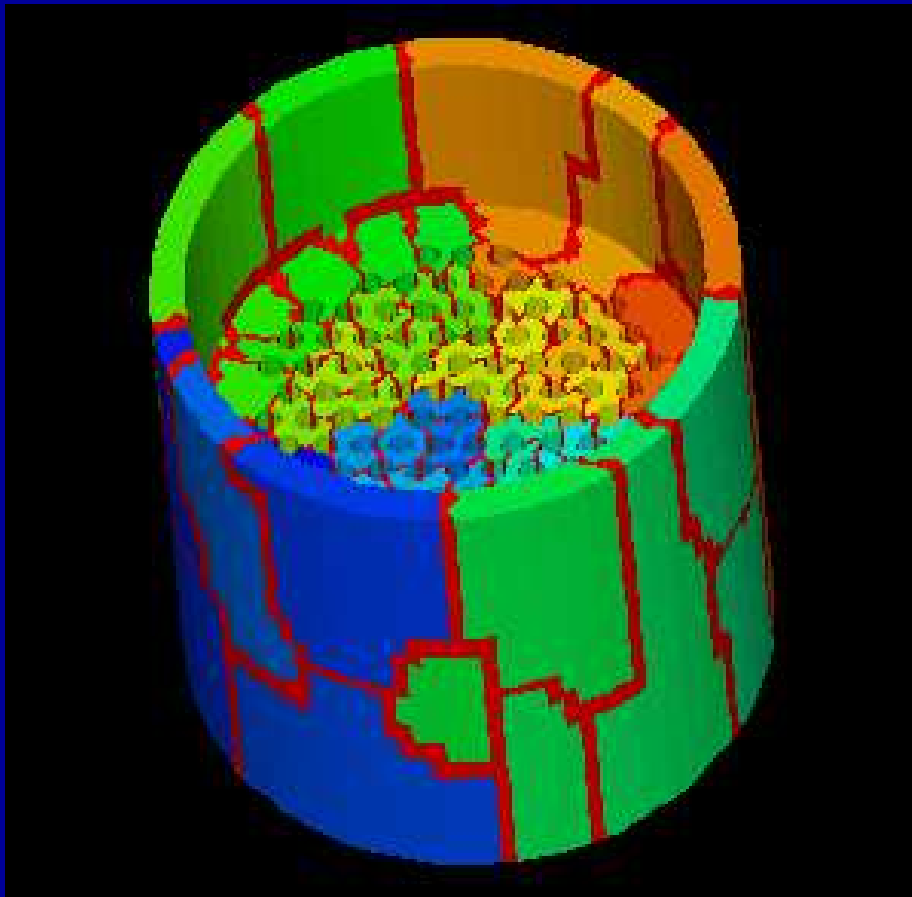

**k-MeTiS**

edgecut = 9,489

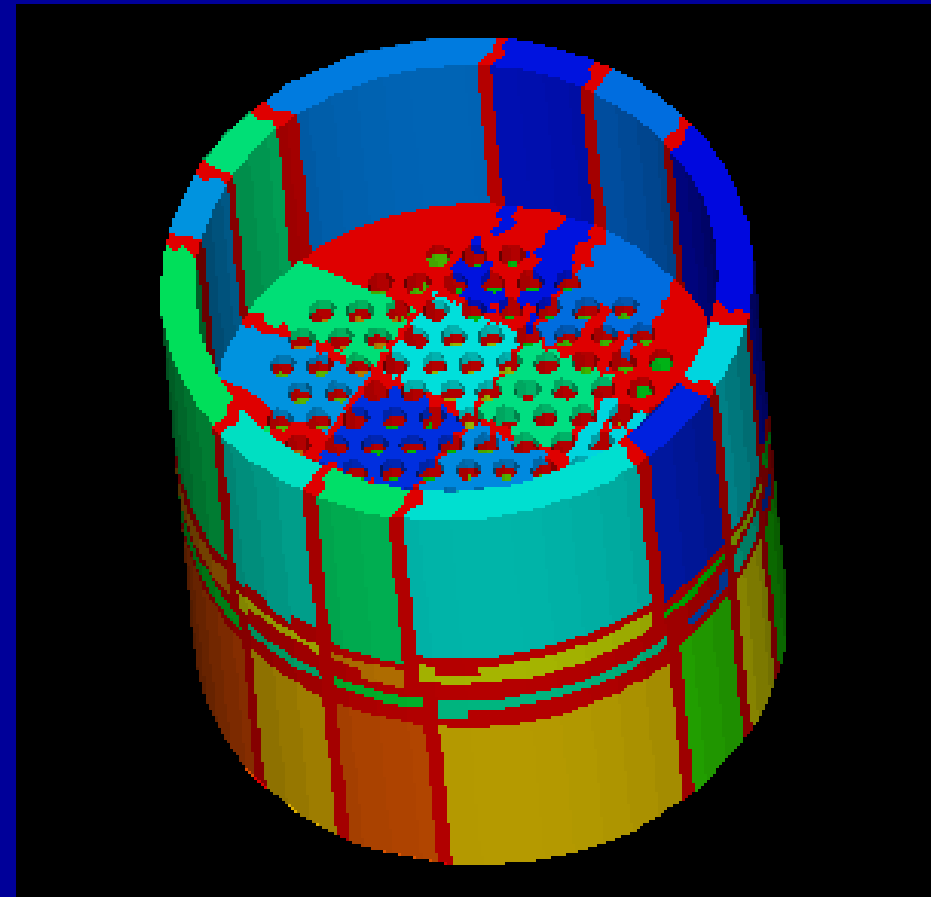

**RCB**

edgecut = 28,320



# Strange Animal in 8 PEs

53,510 elements, 11,749 nodes.

METIS is better for complicated geometries.

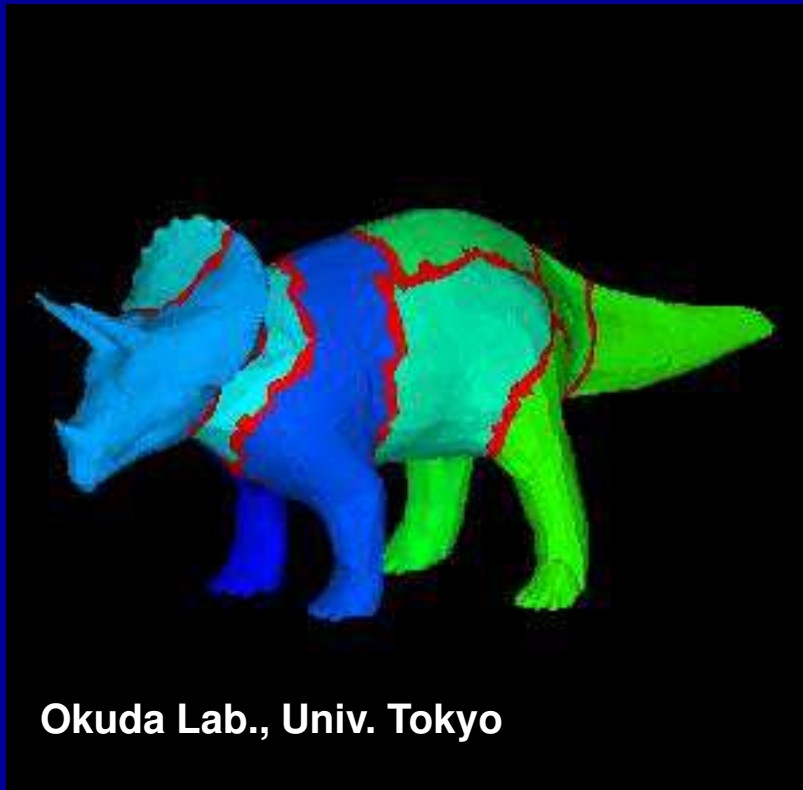

**k-METIS**  
edgecut = 4,573

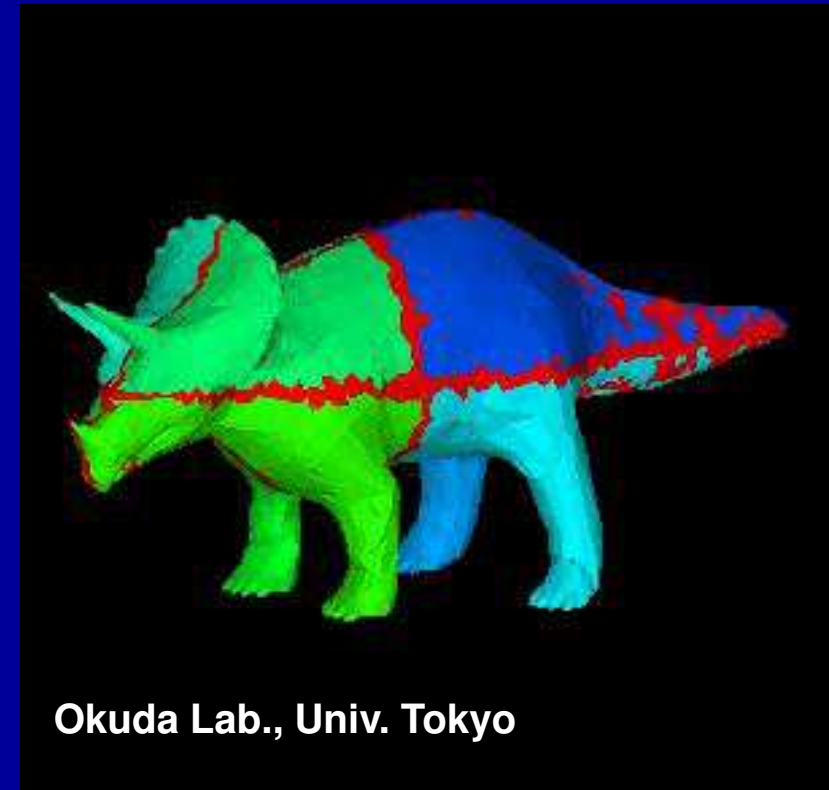

**RCB**  
edgecut = 7,898

# Strange Animal in 8 PEs

53,510 elements, 11,749 nodes.

METIS is better for complicated geometries

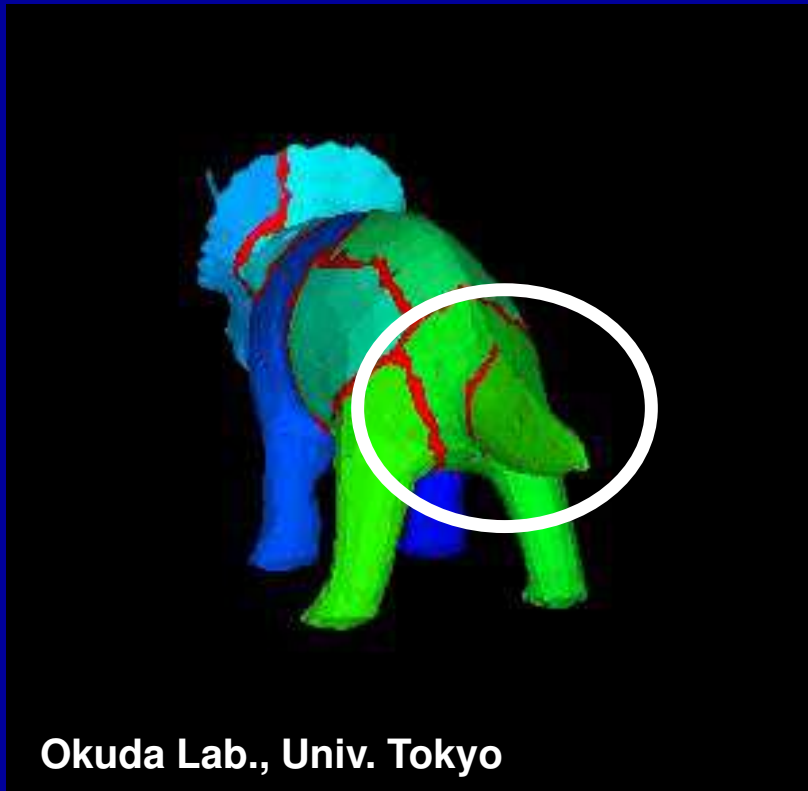

**k-METIS**  
edgecut = 4,573

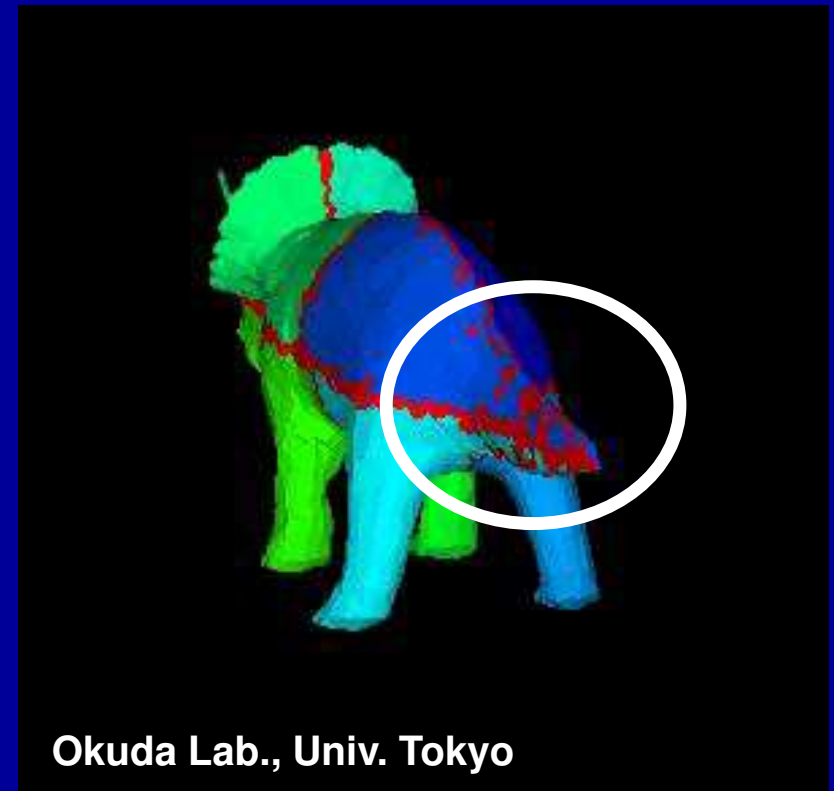

**RCB**  
edgecut = 7,898

# Red Lacquered Gate in 64 PEs

[movie](#)

40,624 elements, 54,659 nodes

METIS is better for complicated geometries

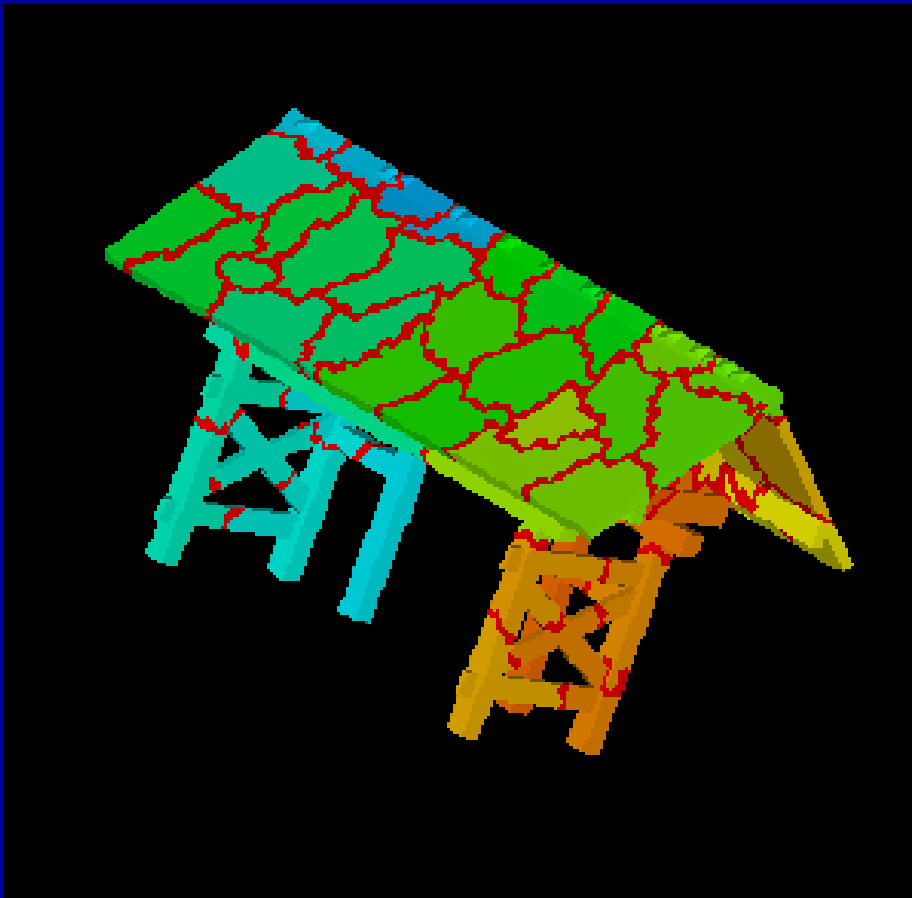

**k-METIS**

edgecut = 7,563

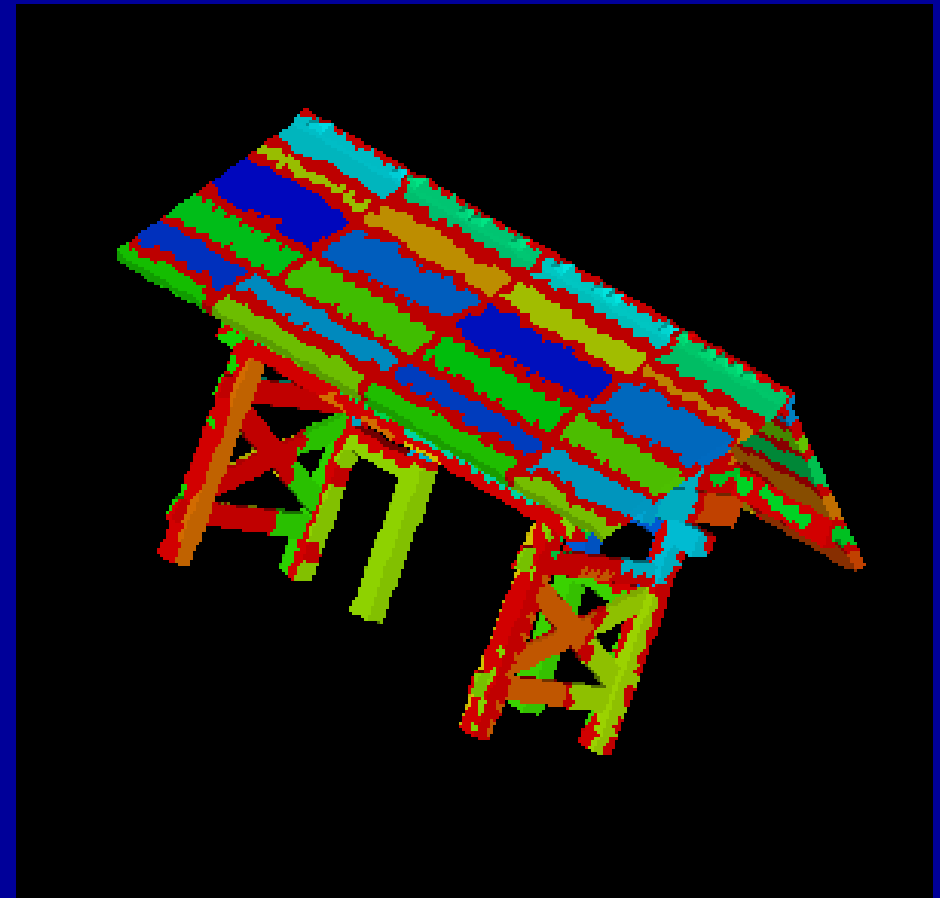

**RCB**

edgecut = 18,624

# Red Lacquered Gate in 64 PEs

40,624 elements, 54,659 nodes

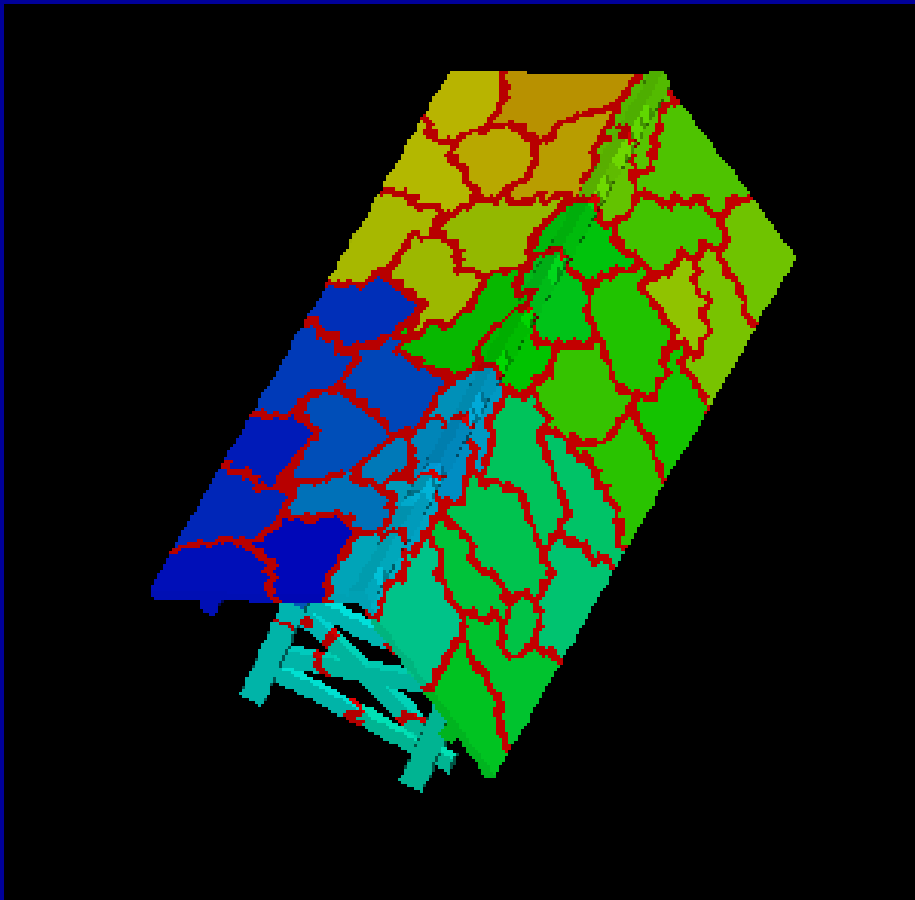

**k-METIS**

Load Balance= 1.03  
edgecut = 7,563

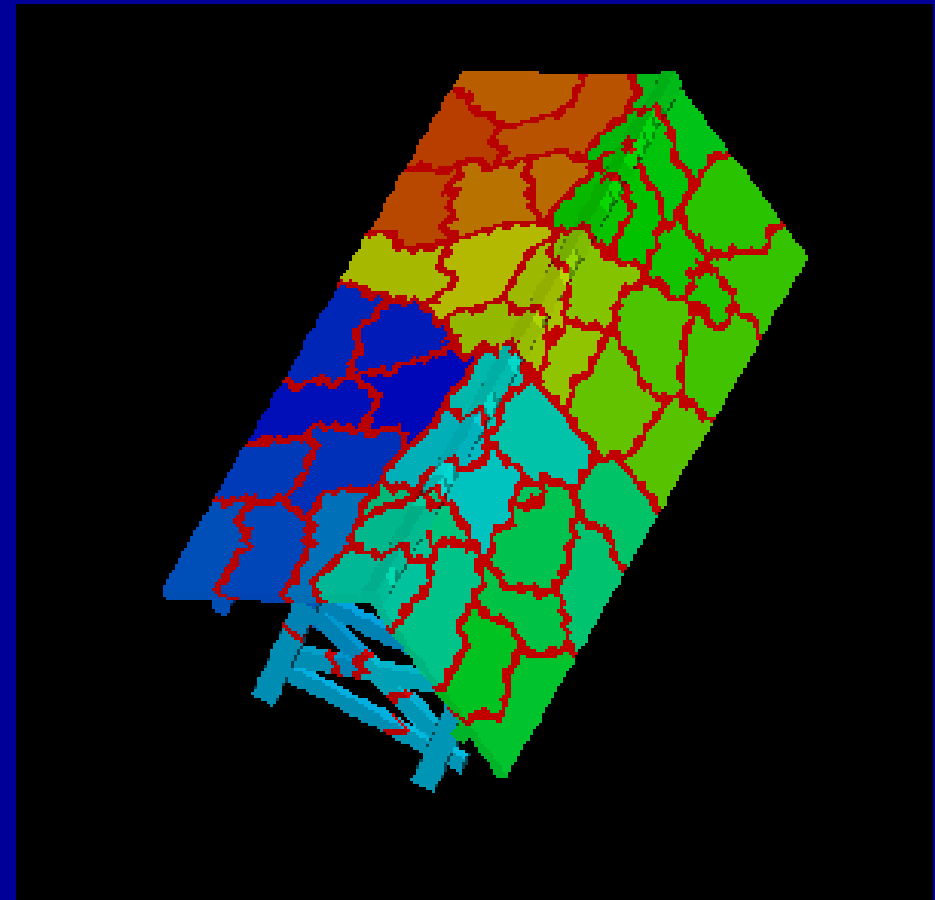

**p-METIS**

Load Balance= 1.00  
edgecut = 7,738

# South-West Japan

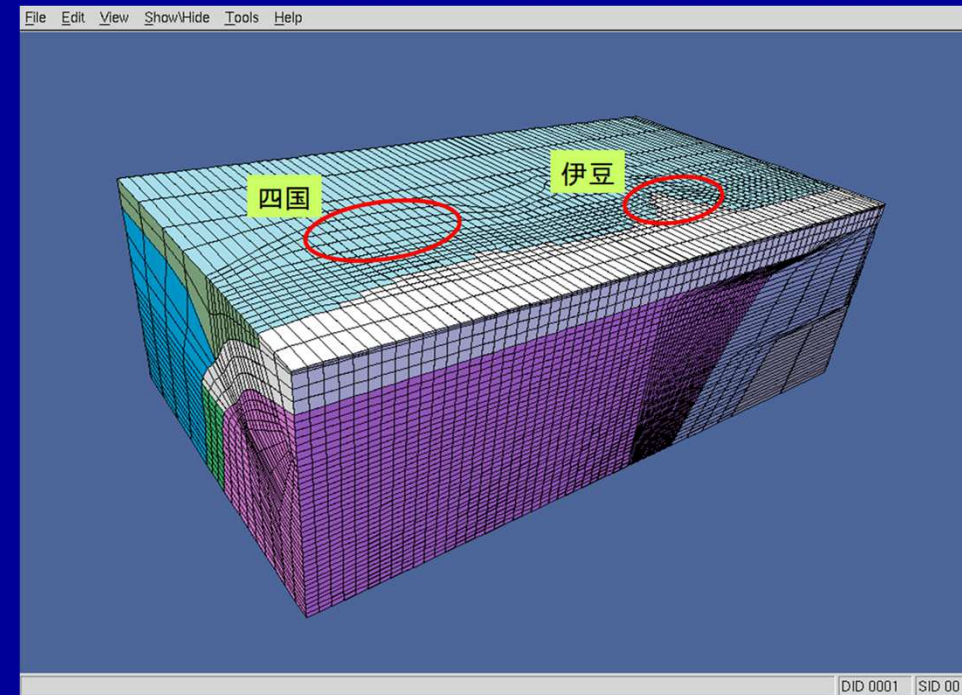
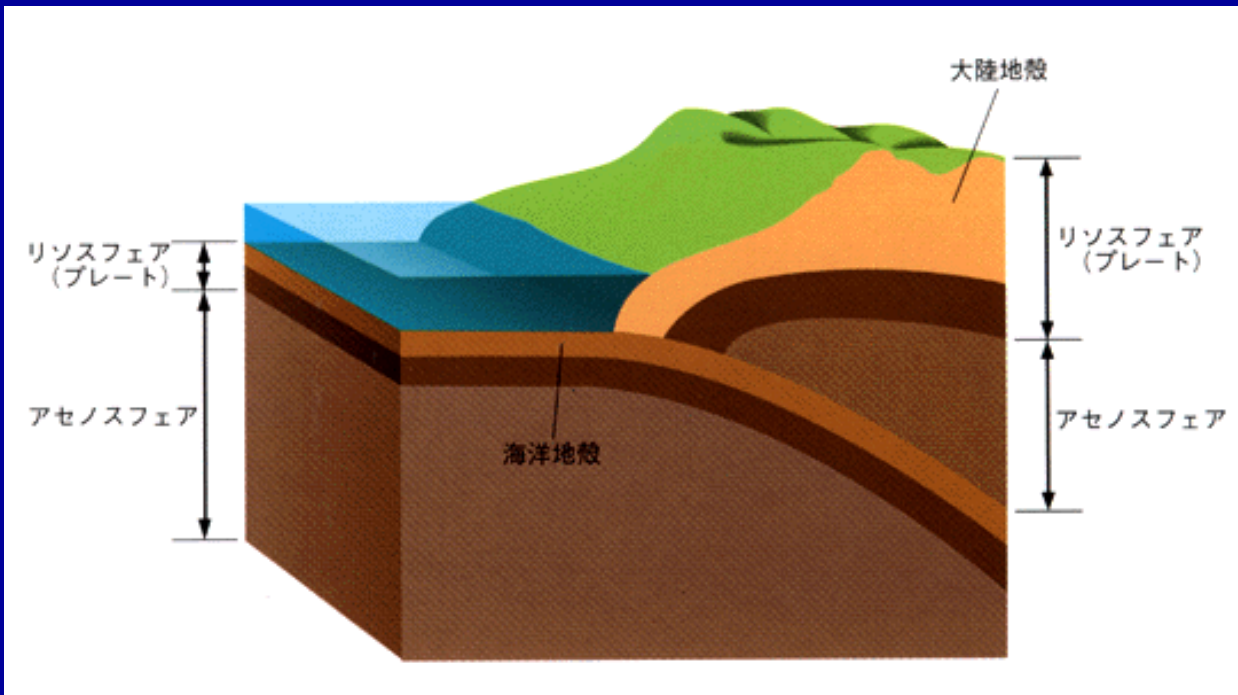

# South-West Japan in 8 PEs

57,205 elem's, 58,544 nodes

movie

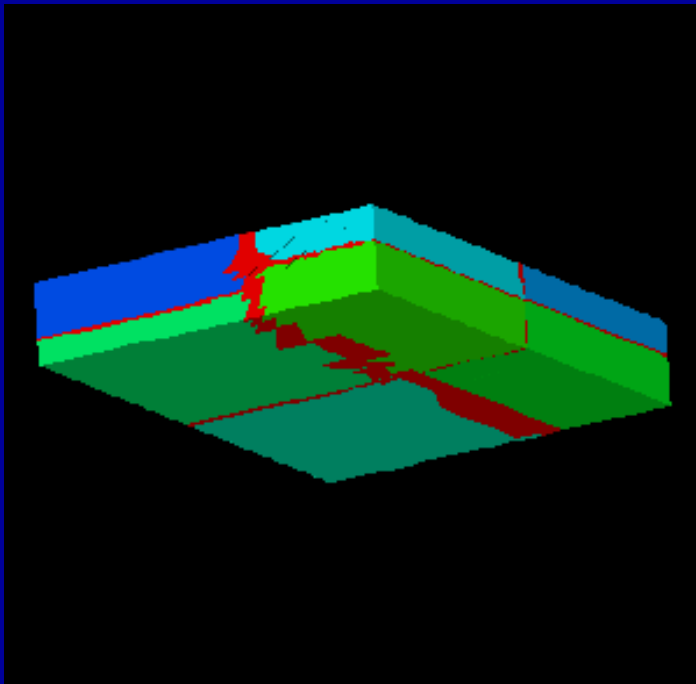
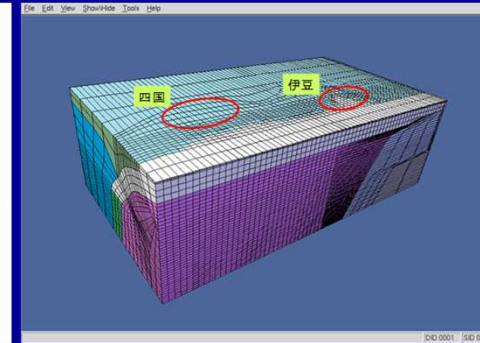
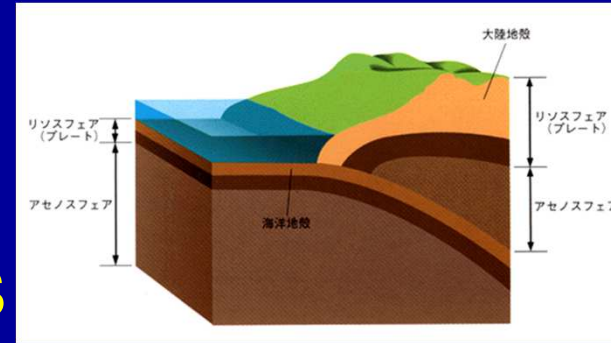

RCB e.c.=7433

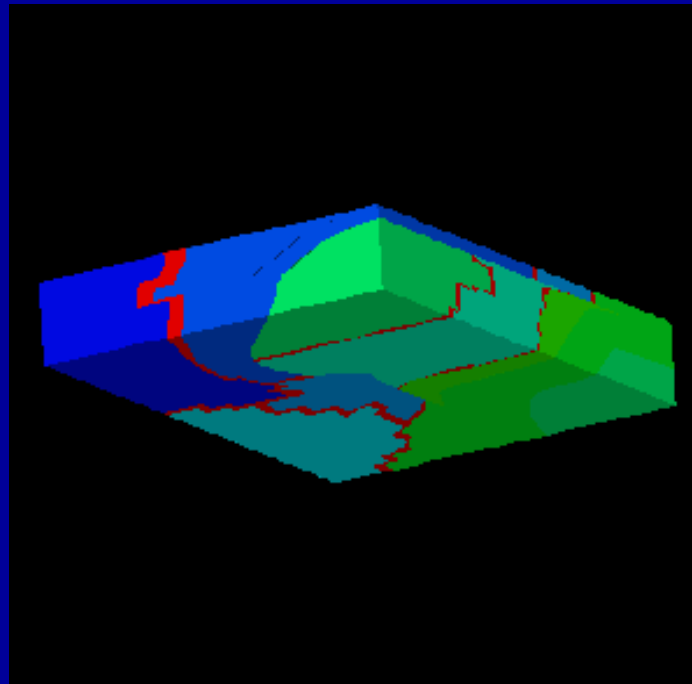

k-METIS :4,221

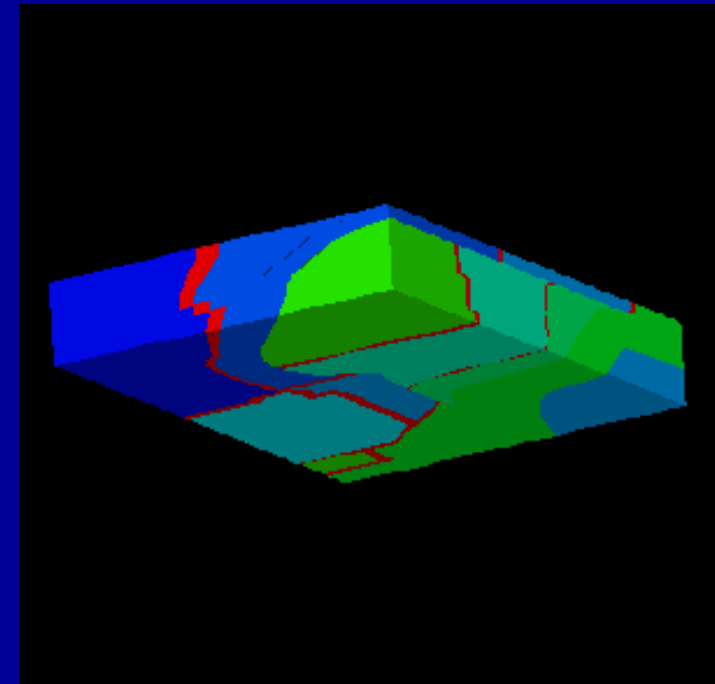

p-METIS :3,672

- Installation
- Execution
  - Procedures of Parallel FEM
  - Domain Decomposition/Partitioning
  - **Real Execution**
- Data Structure

# Procedures for Parallel FEM

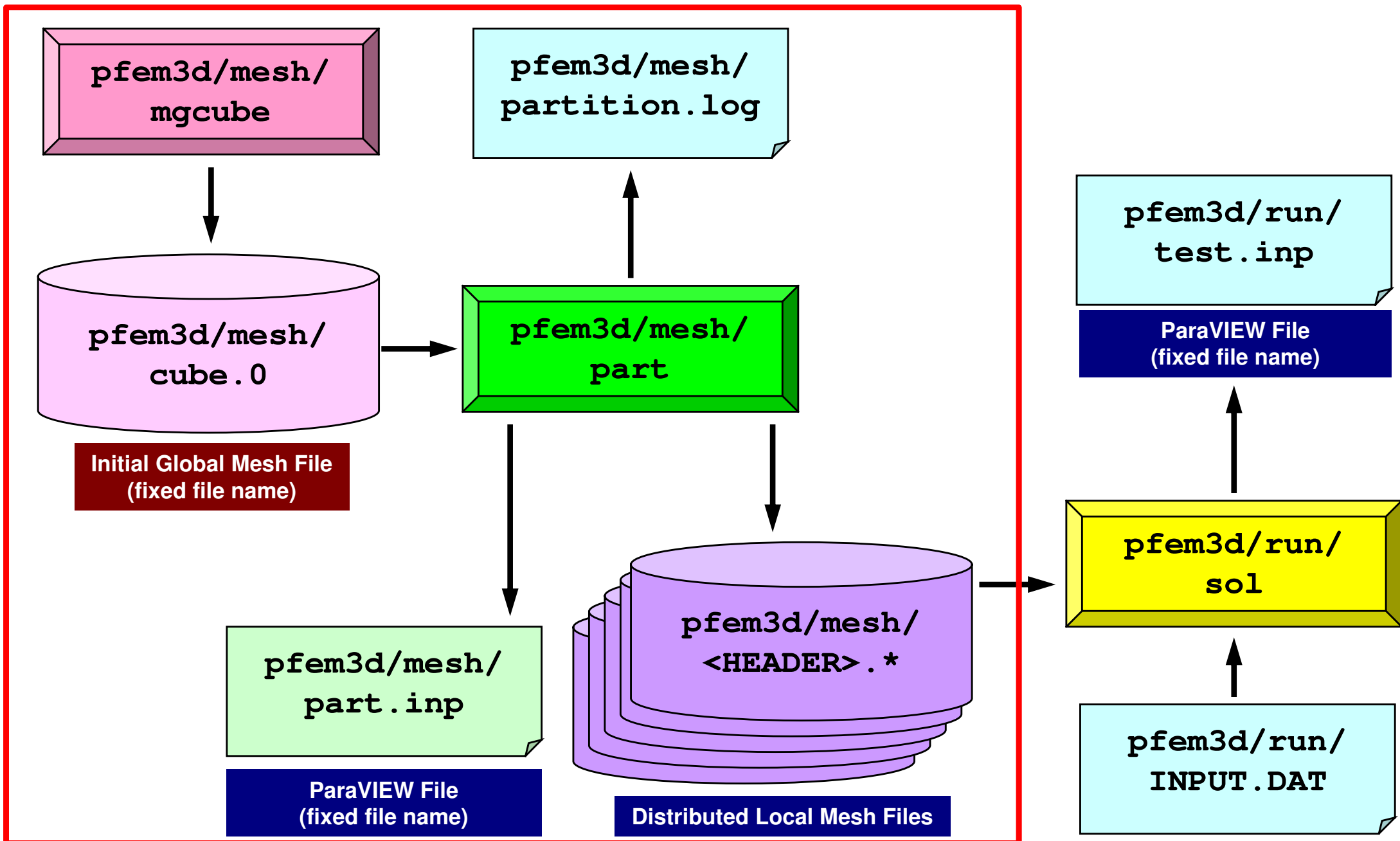



# Initial Global Mesh

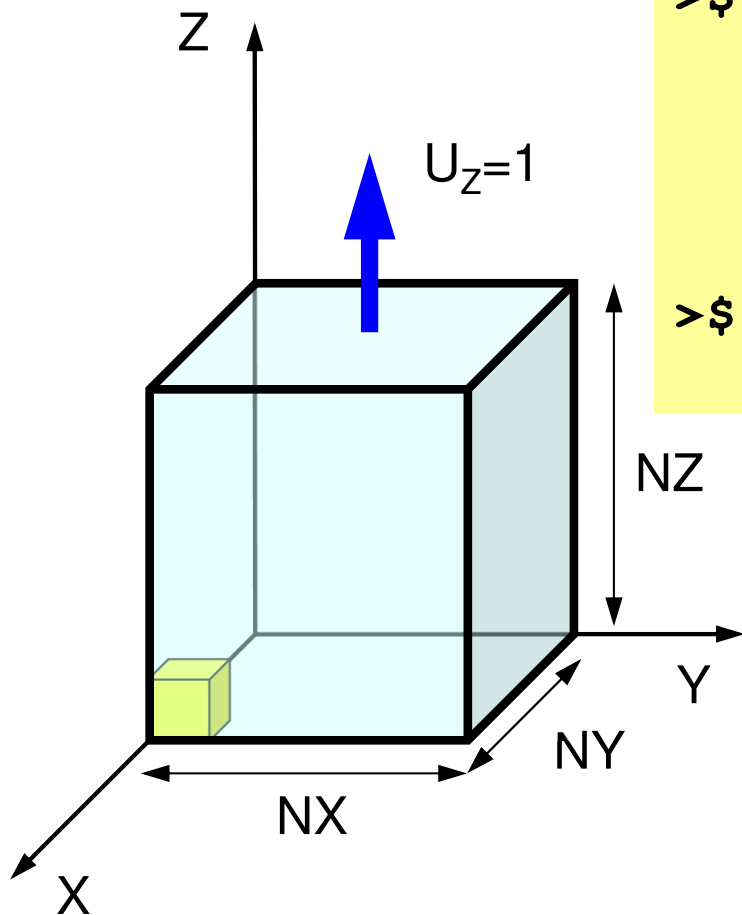

```

>$ cd /work/gt18/t18XYZ/pFEM/pfem3d/mesh
>$ ./mgcube

      NX, NY, NZ          ← Meshes in each
                          direction
      20 20 20           ← 20x20x20 elem's

>$ ls cube.0             confirmation
   cube.0
  
```

This type of interactive execution is not allowed for “education” users on Odyssey.

# Please submit batch-job's !

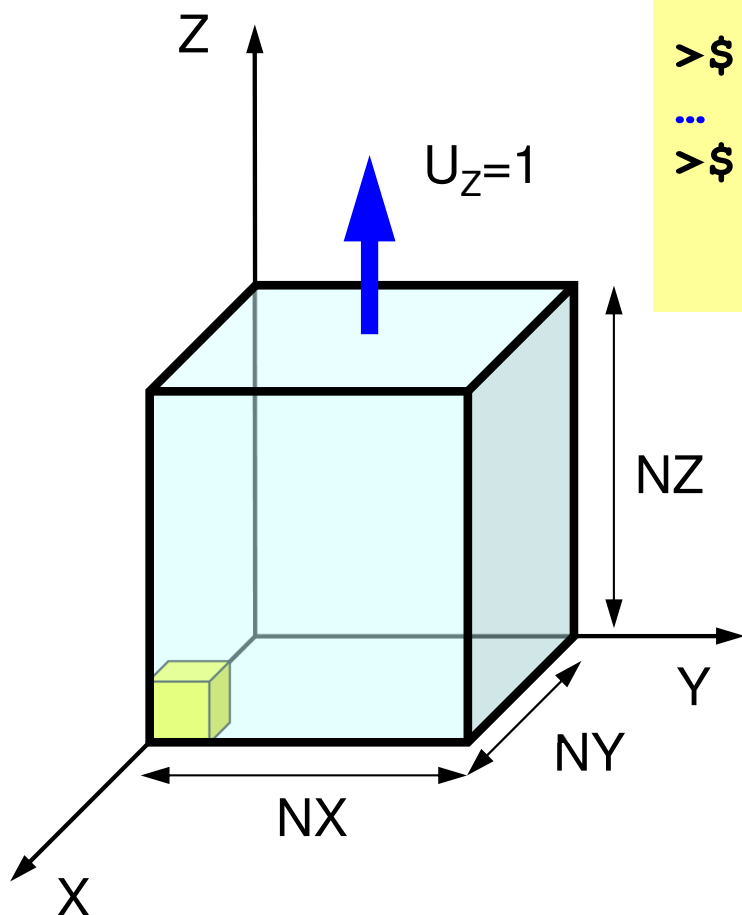

```
>$ cd /work/gt18/t18XYZ/pFEM/pfem3d/mesh
>$ pjsub mg.sh
...
>$ ls cube.0      confirmation

cube.0
```

## mg.sh

```
#!/bin/sh
#PJM -L rscgrp=lecture8-o
#PJM -L node=1
#PJM --mpi proc=1
#PJM -L elapse=00:15:00
#PJM -g gt18
#PJM -j
#PJM -e err
#PJM -o mg.lst
```

```
module load fj
module load fjmpi
```

```
./mgcube < inp_mg
```

## inp\_mg

```
20 20 20
```

# Domain Decomposition/Partitioning

- File name of initial global mesh is fixed (cube.0)
- RCB and METIS are supported
- Header of distributed local mesh files
  - “work” is not allowed as header name
  
- RCB
  - Number of PE's, Reference axes
- METIS
  - Number of PE's

# pFEM/pfem3d/part/Makefile

```
F77      = frtpx
F90      = frtpx
FLINKER  = $(F77)
F90LINKER = $(F90)
FLIB_PATH =
INC_DIR  =
OPTFLAGS = -Kfast
FFLAGS  = $(OPTFLAGS)
FLIBS   = -lmetis

TARGET = ../mesh/part
default: $(TARGET)
OBJS = ¥
geofem_util.o partitioner.o input_grid.o main.o ¥
calc_edgcut.o cre_local_data.o define_file_name.o ¥
interface_nodes.o metis.o¥
neib_pe.o paraset.o proc_local.o local_data.o¥
double_numbering.o output_ucd.o util.o

$(TARGET):  $(OBJS)
             $(F90LINKER) $(OPTFLAGS) -o $(TARGET) $(OBJS) $(FLIBS)
clean:
    /bin/rm -f *.o $(TARGET) *~ *.mod
.f.o:
    $(F90) $(FFLAGS) $(INC_DIR) -c  $*.f
.SUFFIXES: .f
```

```
>$ cd /work/gt87/t87XYZ/pFEM/pfem3d/mesh
```

```
>$ ./part
```

```
Original GRID-FILE ?
```

```
cube.0
```

```
* INODTOT = 9261
```

```
* GRID
```

```
* IELMTOT = 8000
```

```
* ELM
```

```
* BOUNDARY : NODE group
```

```
Xmin
```

```
Ymin
```

```
Zmin
```

```
Zmax
```

```
* IEDGTOT = 26460 37044
```

```
# select PARTITIONING METHOD
```

```
RCB (1)
```

```
K-METIS (2)
```

```
P-METIS (3)
```

```
Please TYPE 1 or 3 or 4 !!
```

```
>>>
```

```
1
```

```
*** RECURSIVE COORDINATE BISECTION (RCB)
```

```
How many partitions (2**n)?
```

```
>>>
```

```
3
```

```
*** 8 REGIONS
```

```
# HEADER of the OUTPUT file ?  
HEADER should not be <work>
```

```
>>>
```

```
aaa
```

```
##### 1-th BiSECTION #####
```

```
in which direction ? X:1, Y:2, Z:3
```

```
>>>
```

```
1
```

```
X-direction
```

```
##### 2-th BiSECTION #####
```

```
in which direction ? X:1, Y:2, Z:3
```

```
>>>
```

```
2
```

```
Y-direction
```

```
##### 3-th BiSECTION #####
```

```
in which direction ? X:1, Y:2, Z:3
```

```
>>>
```

```
3
```

```
Z-direction
```

```
RECURSIVE COORDINATE BISECTION
```

```
*** GRID file
```

```
8 PEs
```

```
TOTAL EDGE # 26460
```

```
TOTAL EDGE CUT # 1593
```

```
TOTAL NODE # 9261
```

```
TOTAL CELL # 8000
```

PE	NODE#	CELL#
0	1158	1223
1	1158	1188
2	1158	1222
3	1158	1176
4	1158	1188
5	1157	1179
6	1157	1188
7	1157	1175

MAX.node/PE	1158
MIN.node/PE	1157
MAX.cell/PE	1223
MIN.cell/PE	1175

OVERLAPPED ELEMENTS 1373

PE/NEIB-PE#	NEIB-PEs							
0 7	7	6	4	5	2	1	3	
1 7	7	5	6	0	2	4	3	
2 7	7	6	0	5	1	4	3	
3 6	7	2	6	1	5	0		
4 6	6	7	5	0	2	1		
5 7	7	6	4	0	1	2	3	
6 7	7	5	4	0	2	1	3	
7 7	6	5	4	0	2	1	3	

PE: 0	1626	1158	468	435
PE: 1	1589	1158	431	411
PE: 2	1620	1158	462	490
PE: 3	1560	1158	402	409
PE: 4	1574	1158	416	421
PE: 5	1565	1157	408	397
PE: 6	1580	1157	423	414
PE: 7	1564	1157	407	440

(Int.+Ext.) Internal External Boundary

KCHF091R STOP \* normal termination

```
>$ ls -l aaa.*
```

```
-rw-r--r-- 1 t18013 t18 268829 Jan 12 14:57 aaa.0
-rw-r--r-- 1 t18013 t18 261490 Jan 12 14:57 aaa.1
-rw-r--r-- 1 t18013 t18 268086 Jan 12 14:57 aaa.2
-rw-r--r-- 1 t18013 t18 257631 Jan 12 14:57 aaa.3
-rw-r--r-- 1 t18013 t18 258719 Jan 12 14:57 aaa.4
-rw-r--r-- 1 t18013 t18 256853 Jan 12 14:57 aaa.5
-rw-r--r-- 1 t18013 t18 259093 Jan 12 14:57 aaa.6
-rw-r--r-- 1 t18013 t18 257161 Jan 12 14:57 aaa.7
```

- Distributed Local Files
  - <HEADER>.<ID of PEs>
  - ID of PEs starting from “0”

Again, this interactive operation is not allowed !

Please submit batch-job's !

# RCB: part\_rcb.sh

## inp\_rcb

### part\_rcb.sh

```
#!/bin/sh
#PJM -N "RCB"
#PJM -L rscgrp=lecture8-o
#PJM -L node=1
#PJM --mpi proc=1
#PJM -L elapse=00:15:00
#PJM -g gt18
#PJM -j
#PJM -e err
#PJM -o test.lst
```

```
module load fj
module load fjmpi
module load metis/4.0.3
```

```
./part < inp_rcb
rm work.*
```

### inp\_rcb

```
cube.0 Initial Global File (fixed)
1      1:RCB, 2:KMETIS, 3:PMETIS
3      m: 2m PE's
aaa    Header of Distributed Local Files
1      Reference Axis (X:1, Y:2, Z:3)
2
3
```

### inp\_rcb: 1-PE

```
cube.0 Initial Global File (fixed)
1      1:RCB, 2:KMETIS, 3:PMETIS
0      m: 2m PE's
aaa    Header of Distributed Local Files
```

# kmetis: part\_kmetis.sh inp\_kmetis

## Minimum Edge-Cut

### part\_kmetis.sh

```
#!/bin/sh
#PJM -N "K-MeTiS"
#PJM -L rscgrp=lecture8-o
#PJM -L node=1
#PJM --mpi proc=1
#PJM -L elapse=00:15:00
#PJM -g gt18
#PJM -j
#PJM -e err
#PJM -o test.lst
```

```
module load fj
module load fjmpi
module load metis/4.0.3
```

```
./part < inp_kmetis
rm work.*
```

### inp\_kmetis

```
cube.0  Initial Global File (fixed)
2       1:RCB, 2:KMETIS, 3:PMETIS
8       Number of PE's
aaa     Header of Distributed Local Files
```



# pmetis: part\_pmetis.sh inp\_pmetis

## Optimum Load-Balancing

### part\_pmetis.sh

```
#!/bin/sh
#PJM -N "P-MeTiS"
#PJM -L rscgrp=lecture8-o
#PJM -L node=1
#PJM --mpi proc=1
#PJM -L elapse=00:15:00
#PJM -g gt18
#PJM -j
#PJM -e err
#PJM -o test.lst
```

```
module load fj
module load fjmpi
module load metis/4.0.3
```

```
./part < inp_pmetis
rm work.*
```

### inp\_pmetis

```
cube.0 Initial Global File (fixed)
3      1:RCB, 2:KMETIS, 3:PMETIS
8      Number of PE's
aaa    Header of Distributed Local Files
```

# partition.log

RECURSIVE COORDINATE BISECTION

\*\*\* GRID file

8 PEs

TOTAL EDGE # 26460  
TOTAL EDGE CUT # 1593

TOTAL NODE # 9261  
TOTAL CELL # 8000

PE	NODE#	CELL#
0	1158	1223
1	1158	1188
2	1158	1222
3	1158	1176
4	1158	1188
5	1157	1179
6	1157	1188
7	1157	1175

MAX.node/PE 1158  
MIN.node/PE 1157  
MAX.cell/PE 1223  
MIN.cell/PE 1175

OVERLAPPED ELEMENTS 1373

PE/NEIB-PE#	NEIB-PEs							
0	7	7	6	4	5	2	1	3
1	7	7	5	6	0	2	4	3
2	7	7	6	0	5	1	4	3
3	6	7	2	6	1	5	0	
4	6	6	7	5	0	2	1	
5	7	7	6	4	0	1	2	3
6	7	7	5	4	0	2	1	3
7	7	6	5	4	0	2	1	3

# Procedures for Parallel FEM

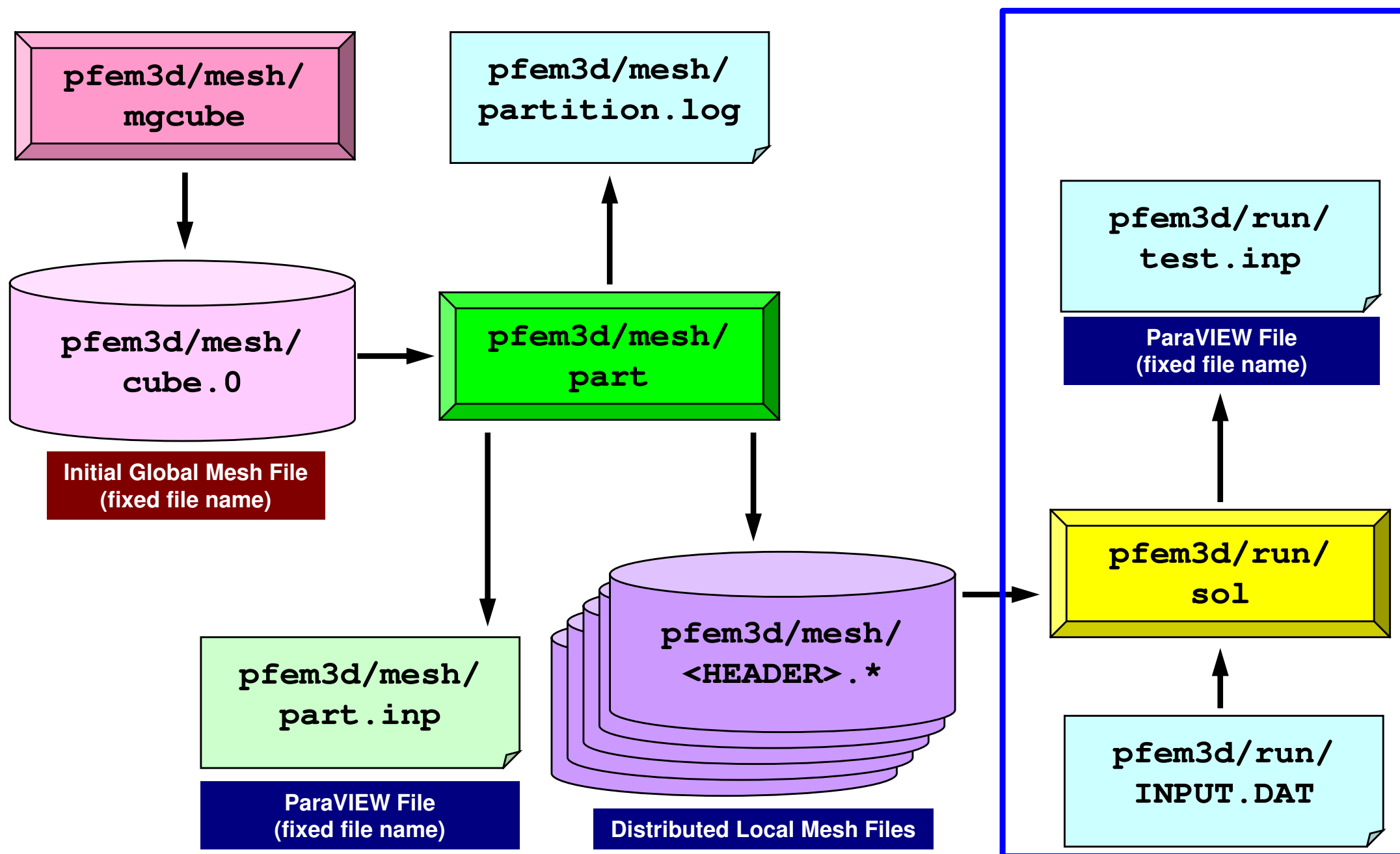

# INPUT.DAT (fixed name)

## INPUT.DAT

```

./mesh/aaa      HEADER
2000            ITER
1.0 1.0        COND, QVOL
1.0e-08        RESID

```

- **HEADER:** Header of Distributed Local Files
- **ITER:** Max. Number of Iterations
- **COND:** Thermal Conductivity
- **QVOL:** Heat Generation Rate
- **RESID:** Convergence Criteria for CG Method

$$\frac{\partial}{\partial x} \left( \lambda \frac{\partial T}{\partial x} \right) + \frac{\partial}{\partial y} \left( \lambda \frac{\partial T}{\partial y} \right) + \frac{\partial}{\partial z} \left( \lambda \frac{\partial T}{\partial z} \right) + \dot{Q}(x, y, z) = 0$$

$$\dot{Q}(x, y, z) = QVOL |x_c + y_c|$$

# pFEM/pfem3d/run/a08.sh

```
#!/bin/sh
#PJM -N "flat-08"                Job Name
#PJM -L rscgrp=lecture8-o        Name of "Queue/Resource Group"
#PJM -L node=8                  Node #
#PJM -mpi proc=384              Total MPI # (384/8= 48 per node)
#PJM -L elapse=00:15:00         Computation Time
#PJM -g gt18                    Group Name (Wallet)
#PJM -j
#PJM -e err                      Standard Error
#PJM -o a08.lst                 Standard Output

module load fj
module load fjmpi

mpiexec ./sol
mpiexec numactl -l ./sol
```

# Number of Processes

```
#PJM -L node=1; #PJM --mpi proc= 1      1-node, 1-proc, 1-proc/n
#PJM -L node=1; #PJM --mpi proc= 4      1-node, 4-proc, 4-proc/n
#PJM -L node=1; #PJM --mpi proc=12     1-node, 12-proc, 12-proc/n
#PJM -L node=1; #PJM --mpi proc=24     1-node, 24-proc, 24-proc/n
#PJM -L node=1; #PJM --mpi proc=48     1-node, 48-proc, 48-proc/n
```

```
#PJM -L node= 4; #PJM --mpi proc=192   4-node, 192-proc, 48-proc/n
#PJM -L node= 8; #PJM --mpi proc=384   8-node, 384-proc, 48-proc/n
#PJM -L node=12; #PJM --mpi proc=576  12-node, 576-proc, 48-proc/n
```

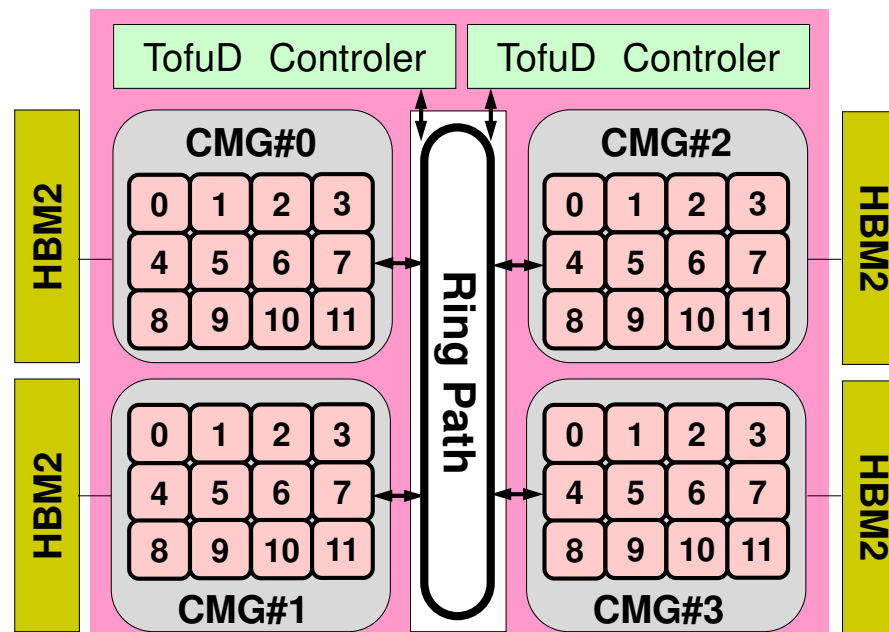

# Example: k-MeTis (1/2) (8-part's)

```
>$ cd /work/gt18/t18XYZ/pFEM/pfem3d/mesh
```

```
<modify inp_mg, mg.sh, inp_kmetis>
```

```
<modify part_kmetis.sh>
```

```
>$ pjsub mg.sh
```

```
>$ pjsub part_kmetis.sh
```

inp\_mg

31 31 31

inp\_kmetis

cube . 0

2

8

aaa

$31^3$  elements

$32^3$  nodes

$2^3 = 8$  partitions

# Example: k-MeTis (2/2) (8-part's)

```
>$ cd ../run
<modify INPUT.DAT, test.sh>
>$ pjsub test.sh
```

## INPUT.DAT

```
../mesh/aaa
2000
1.0 1.0
1.0e-08
```

## test.sh

```
#!/bin/sh
#PJM -N "flat-02"
#PJM -L rscgrp=lecture8-o
#PJM -L node=1
#PJM -mpi proc=8
#PJM -L elapse=00:15:00
#PJM -g gt18
#PJM -j
#PJM -e err
#PJM -o test.lst

module load fj
module load fjmpi

mpiexec ./sol
```

## test.lst

```
*** matrix conn.      3.643613E-03 sec.
*** matrix ass.      4.854173E-03 sec.

   1   5.189549E+00
   2   4.822416E+00
   3   4.514909E+00
   4   4.253956E+00
   5   4.030138E+00
(...)
  91   7.309762E-08
  92   3.569387E-08
  93   1.914244E-08
  94   1.314290E-08
  95   6.435628E-09
*** real COMP.      6.575127E-02 sec.

      3      1      1.262583E+04
* normal termination
```

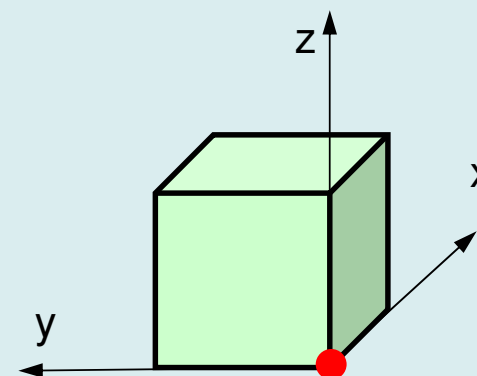



# Validation: Single CPU on PC

31<sup>3</sup> elements  
32<sup>3</sup> nodes

## INPUT.DAT

```
cube . 0
2000
1.0 1.0
1.0e-08
```

```
1 5.189549E+00
2 4.822416E+00
3 4.514909E+00
4 4.253956E+00
5 4.030138E+00
```

(...)

```
91 7.309762E-08
92 3.569387E-08
93 1.914244E-08
94 1.314290E-08
95 6.435628E-09
```

```
1 1.262583E+04
```

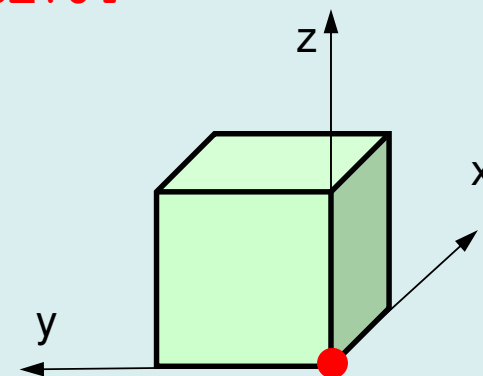

- Installation
- Execution
  - Procedures of Parallel FEM
  - Domain Decomposition/Partitioning
  - Real Execution
- **Data Structure**

# Attention !!

- Processes of mesh generation & partitioning are not parallelized, therefore it is very expensive in the following cases:
  - larger meshes
  - more domains
- **Parallel mesh generator is also available.**
  - Generally, this procedure is used in this class
  - But partitioning using METIS is very flexible.

# Distributed Local Meshes

```

>$ cd /work/gt18/t18XYZ/pFEM/pfem3d/pmesh
>$ cp /work/gt18/share/pmesh/pmesh.f .
>$ mpifrtpx -Kfast pmesh.f -o pmesh

>$ <modify "mg.sh", "mesh.inp">
>$ pjsub mg.sh

```

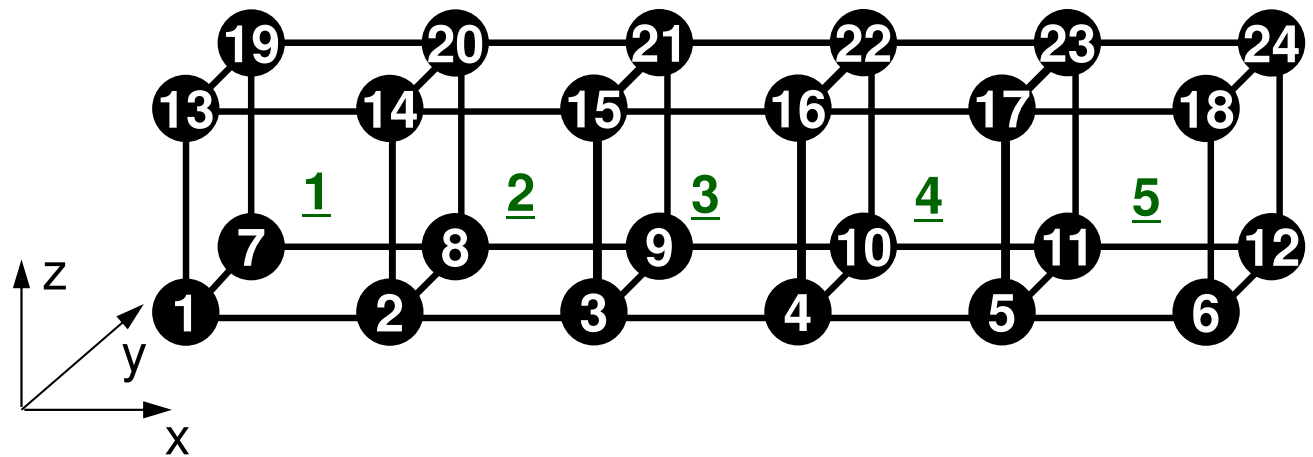
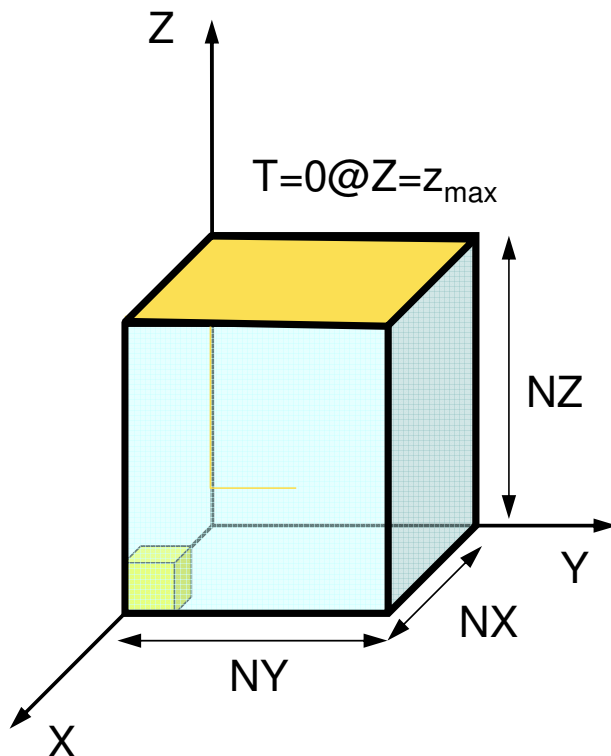

# “mesh.inp”: parallel mesh generation

(values)	(variables)	(descriptions)
6 2 2	<b>np<sub>x</sub>, np<sub>y</sub>, np<sub>z</sub></b>	Total number of nodes in X-, Y-, and Z-direction (N <sub>x</sub> , N <sub>y</sub> , N <sub>z</sub> in the prev. page)
2 1 1	<b>nd<sub>x</sub>, nd<sub>y</sub>, nd<sub>z</sub></b>	Partition # in each direction (X,Y,Z)
<b>pcube</b>	<b>HEADER</b>	Header of distributed local file

- Each of “np<sub>x</sub>, np<sub>y</sub>, np<sub>z</sub>” must be “divisible (割り切れる)” by each of “nd<sub>x</sub>, nd<sub>y</sub>, nd<sub>z</sub>”
- MPI process # = nd<sub>x</sub> × nd<sub>y</sub> × nd<sub>z</sub>

– In this case,  
 6x2x2 nodes,  
 5x1x1 elem's,  
 2 partitions in X-direction

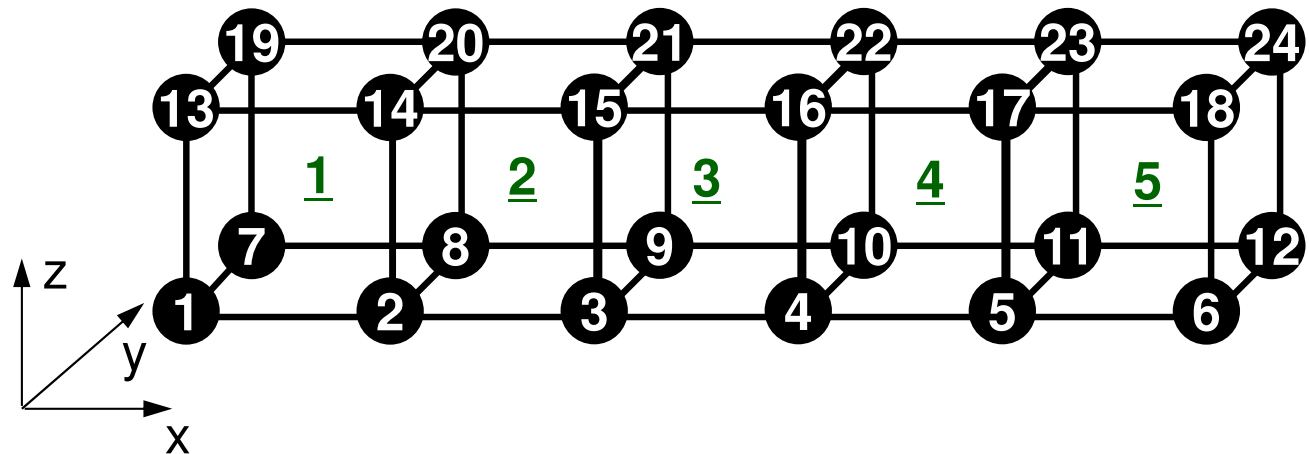

# mg.sh: parallel mesh generation

"proc" must be equal to  $(ndx \times ndy \times ndz)$

Each MPI process generates each local mesh file

## mg.sh

```
#!/bin/sh
#PJM -N "pmg"
#PJM -L rscgrp=lecture8-o
#PJM -L node=1
#PJM --mpi proc=2
#PJM -L elapse=00:10:00
#PJM -g gt18
#PJM -j
#PJM -e err
#PJM -o pmg.lst

module load fj
module load fjmpi
mpiexec ./pmesh

rm wk.*
```

# Example: pmesh (1/2) (8-part's)

```
>$ cd /work/gt18/t18XYZ/pFEM/pfem3d/pmesh  
<modify mesh.inp, mg.sh>
```

```
>$ pjsub mg.sh
```

## mesh.inp

```
 32  32  32  
  2   2   2  
pcube
```

$31^3$  elements  
 $32^3$  nodes  
 $2^3 = 8$  partitions

## mg.sh

```
#!/bin/sh  
#PJM -N "pmg"  
#PJM -L rscgrp=lecture8-o  
#PJM -L node=1  
#PJM --mpi proc=2  
#PJM -L elapse=00:10:00  
#PJM -g gt18  
#PJM -j  
#PJM -e err  
#PJM -o pmg.lst  
  
module load fj  
module load fjmpi  
mpiexec ./pmesh  
  
rm wk.*
```

# Example: pmesh (2/2) (8-part's)

```
>$ cd ../run
<modify INPUT.DAT, test.sh>

>$ pjsub test.sh
```

## INPUT.DAT

```
../pmesh/pcube
2000
1.0 1.0
1.0e-08
```

## test.sh

```
#!/bin/sh
#PJM -N "flat-02"
#PJM -L rscgrp=lecture8-o
#PJM -L node=1
#PJM --mpi proc=8
#PJM -L elapse=00:15:00
#PJM -g gt18
#PJM -j
#PJM -e err
#PJM -o test.lst

module load fj
module load fjmpi
mpiexec ./sol
```

## test.lst

```
*** matrix conn.          3.643613E-03 sec.
*** matrix ass.          4.854173E-03 sec.

   1    5.189549E+00
   2    4.822416E+00
   3    4.514909E+00
   4    4.253956E+00
   5    4.030138E+00
(...)
  91    7.309762E-08
  92    3.569387E-08
  93    1.914244E-08
  94    1.314290E-08
  95    6.435628E-09
*** real COMP.           6.575127E-02 sec.

      0      1      1.262583E+04
* normal termination
```

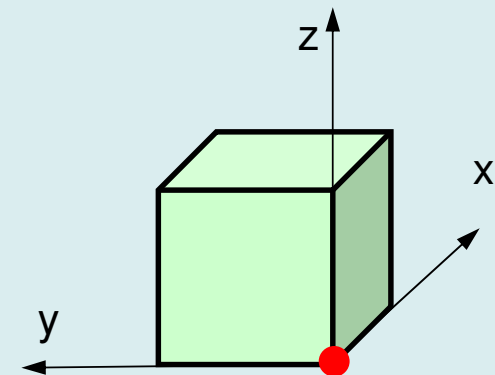



# “mesh.inp”: parallel mesh generation

(values)	(variables)	(descriptions)
6 2 2	<b>np<sub>x</sub>, np<sub>y</sub>, np<sub>z</sub></b>	Total number of nodes in X-, Y-, and Z-direction (N <sub>x</sub> , N <sub>y</sub> , N <sub>z</sub> in the prev. page)
2 1 1	<b>nd<sub>x</sub>, nd<sub>y</sub>, nd<sub>z</sub></b>	Partition # in each direction (X,Y,Z)
<b>pcube</b>	<b>HEADER</b>	Header of distributed local file

- Each of “np<sub>x</sub>, np<sub>y</sub>, np<sub>z</sub>” must be “divisible (割り切れる)” by each of “nd<sub>x</sub>, nd<sub>y</sub>, nd<sub>z</sub>”
- MPI process # = nd<sub>x</sub> × nd<sub>y</sub> × nd<sub>z</sub>

– In this case,  
 6x2x2 nodes,  
 5x1x1 elem's,  
 2 partitions in X-direction

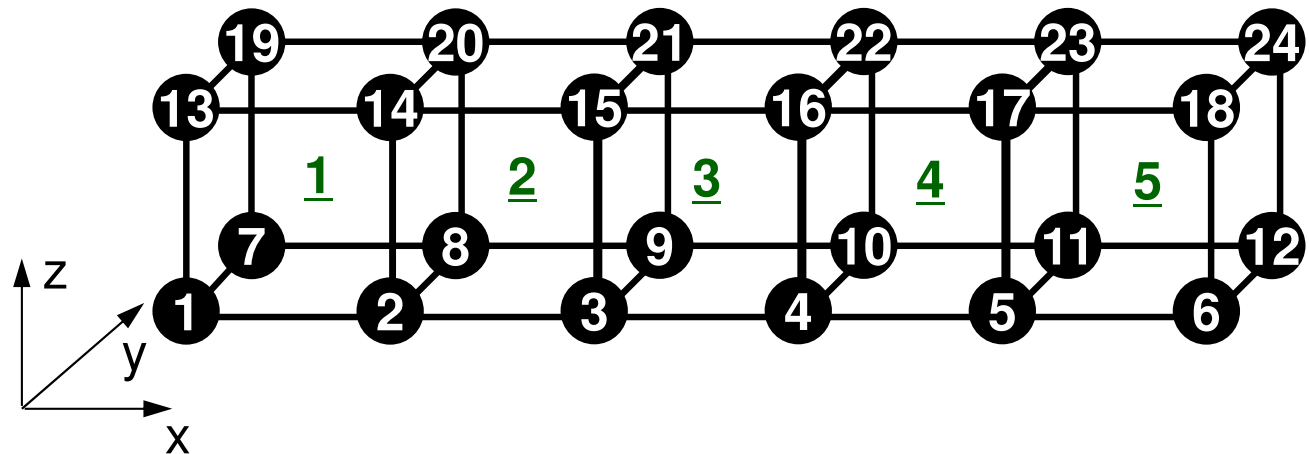

# Initial Global Mesh (1/2)

24

1	0.000000E+00	0.000000E+00	0.000000E+00
2	1.000000E+00	0.000000E+00	0.000000E+00
3	2.000000E+00	0.000000E+00	0.000000E+00
4	3.000000E+00	0.000000E+00	0.000000E+00
5	4.000000E+00	0.000000E+00	0.000000E+00
6	5.000000E+00	0.000000E+00	0.000000E+00
7	0.000000E+00	1.000000E+00	0.000000E+00
8	1.000000E+00	1.000000E+00	0.000000E+00
9	2.000000E+00	1.000000E+00	0.000000E+00
10	3.000000E+00	1.000000E+00	0.000000E+00
11	4.000000E+00	1.000000E+00	0.000000E+00
12	5.000000E+00	1.000000E+00	0.000000E+00
13	0.000000E+00	0.000000E+00	1.000000E+00
14	1.000000E+00	0.000000E+00	1.000000E+00
15	2.000000E+00	0.000000E+00	1.000000E+00
16	3.000000E+00	0.000000E+00	1.000000E+00
17	4.000000E+00	0.000000E+00	1.000000E+00
18	5.000000E+00	0.000000E+00	1.000000E+00
19	0.000000E+00	1.000000E+00	1.000000E+00
20	1.000000E+00	1.000000E+00	1.000000E+00
21	2.000000E+00	1.000000E+00	1.000000E+00
22	3.000000E+00	1.000000E+00	1.000000E+00
23	4.000000E+00	1.000000E+00	1.000000E+00
24	5.000000E+00	1.000000E+00	1.000000E+00

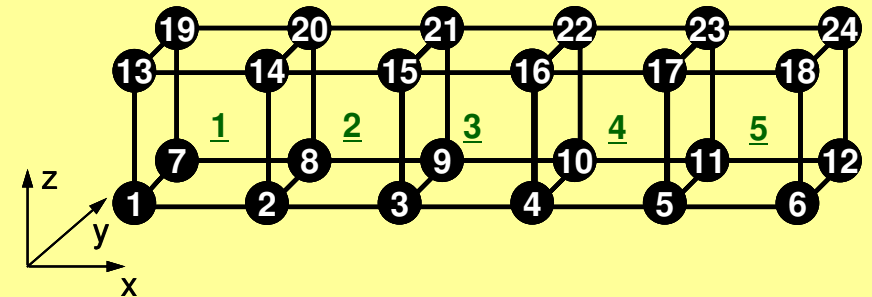

5										
361	361	361	361	361						
1	1	1	2	8	7	13	14	20	19	
2	1	2	3	9	8	14	15	21	20	
3	1	3	4	10	9	15	16	22	21	
4	1	4	5	11	10	16	17	23	22	
5	1	5	6	12	11	17	18	24	23	

# Initial Global Mesh (2/2)

	4											
Xmin	4	16	28	40								
Ymin	1	7	13	19								
Zmin	1	2	3	4	5	6	13	14	15	16		
	17	18										
Zmax	1	2	3	4	5	6	7	8	9	10		
	11	12										
	13	14	15	16	17	18	19	20	21	22		
	23	24										

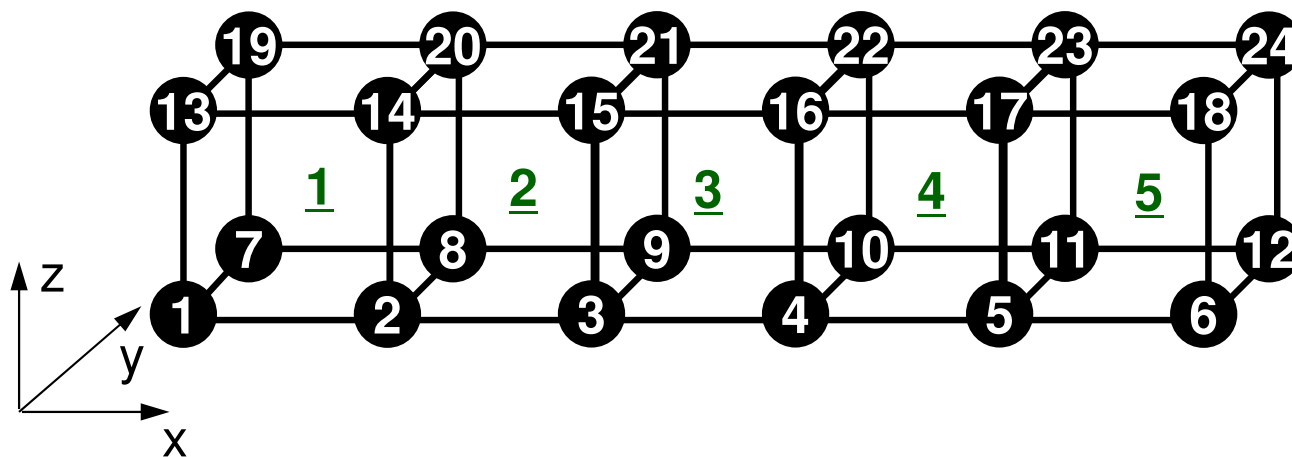

# RCB: 2 PE's in X-direction

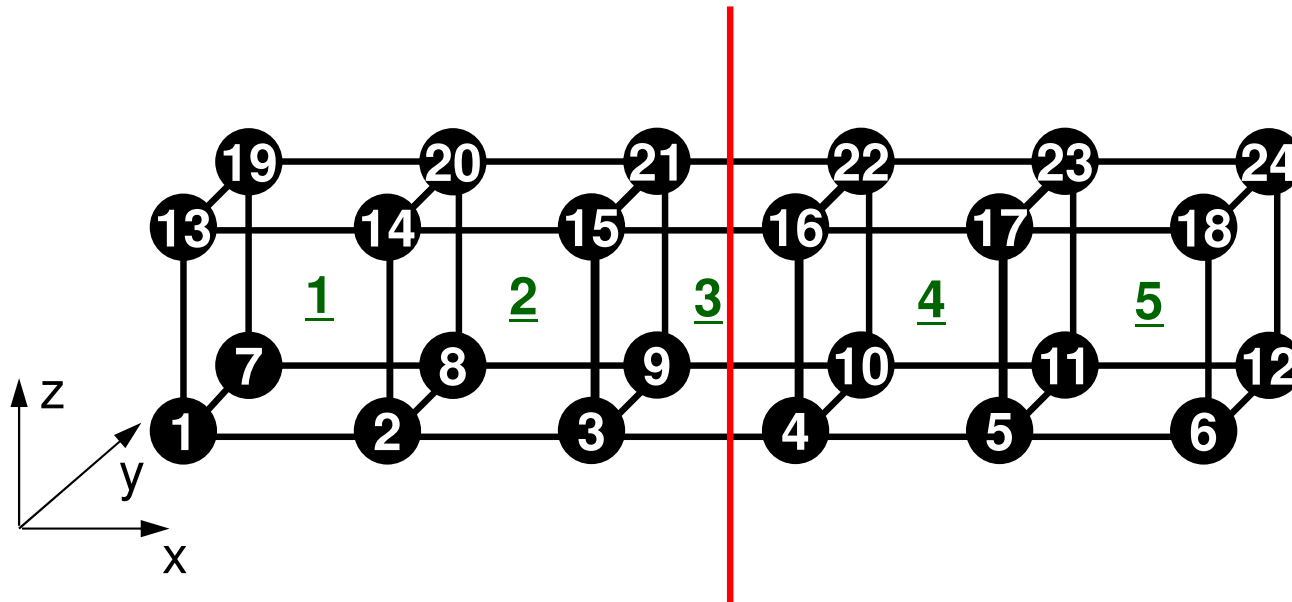

# RCB: 2 PE's in X-direction

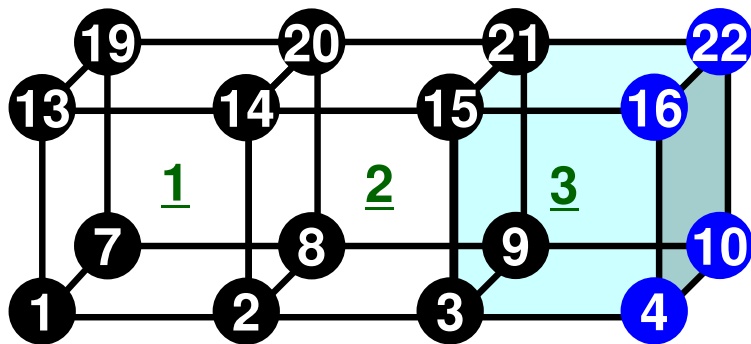
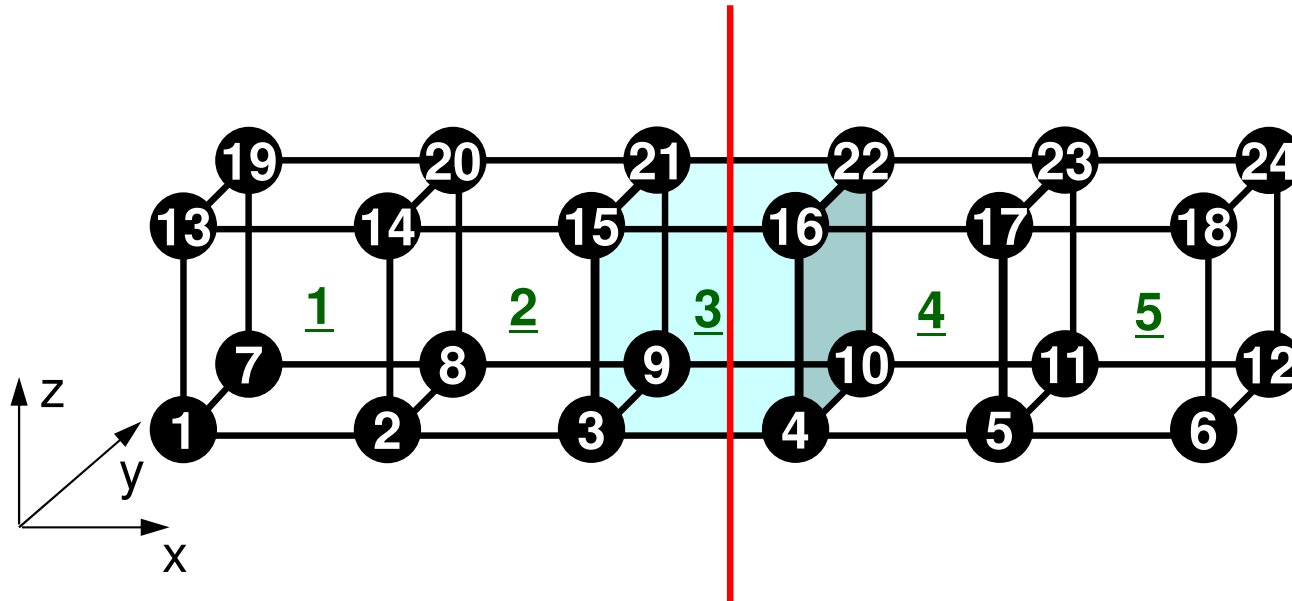

pcube.0

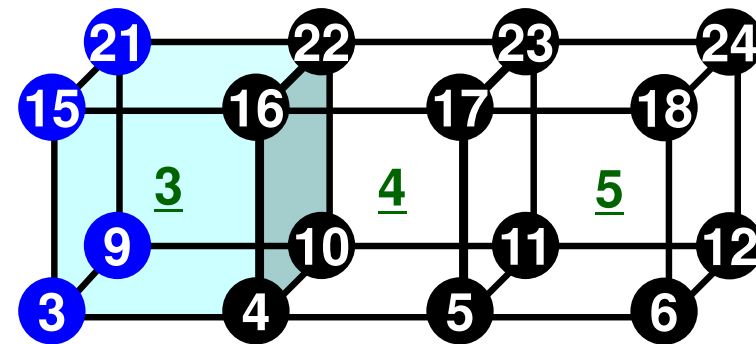

pcube.1

# Distributed Local Mesh Files

- **Neighbors**
- Nodes
- Elements
- **Communication Table (Import/Recv)**
- **Communication Table (Export/Send)**
- Node Groups

# Node-based Partitioning

internal nodes - elements - external nodes

- Partitioned nodes themselves (Internal Nodes) 内点

- Elements which include Internal Nodes 内点を含む要素

- External Nodes included in the Elements 外点  
in overlapped region among partitions.

- Info of External Nodes are required for completely local element-based operations on each processor.

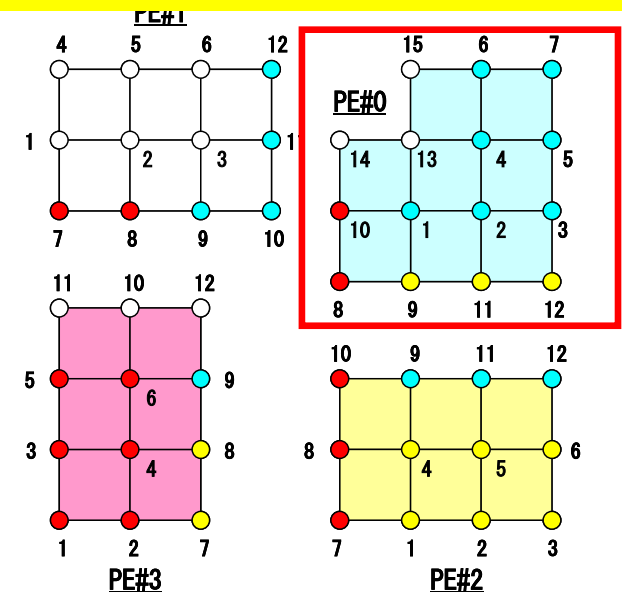
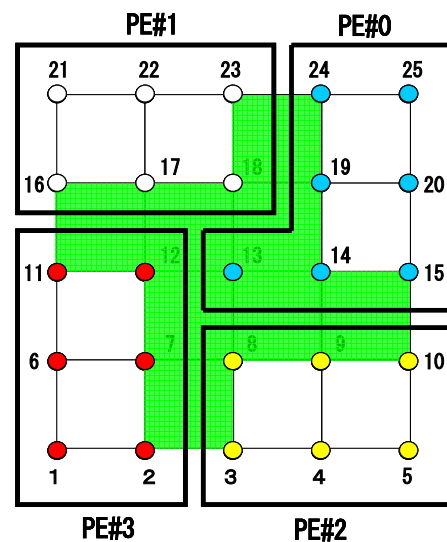
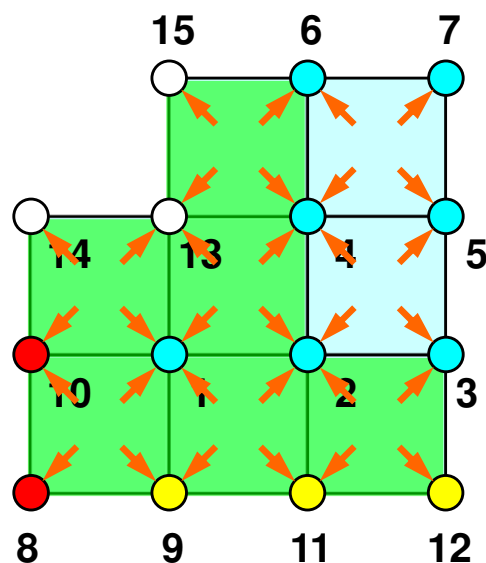

# Description of Distributed Local Data

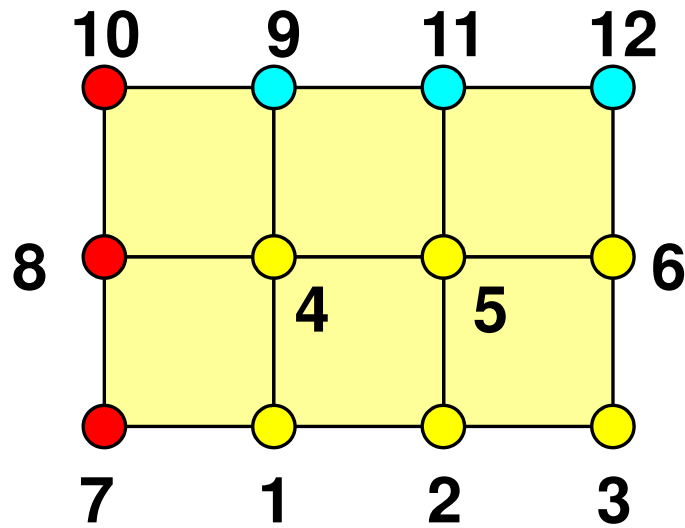

- **Internal/External Points**
  - Numbering: Starting from internal pts, then external pts after that
- **Neighbors**
  - Shares overlapped meshes
  - Number and ID of neighbors
- **External Points**
  - From where, how many, and which external points are received/imported ?
- **Boundary Points**
  - To where, how many and which boundary points are sent/exported ?



# Boundary Nodes (境界点) : SEND

PE#2 : send information on “boundary nodes”

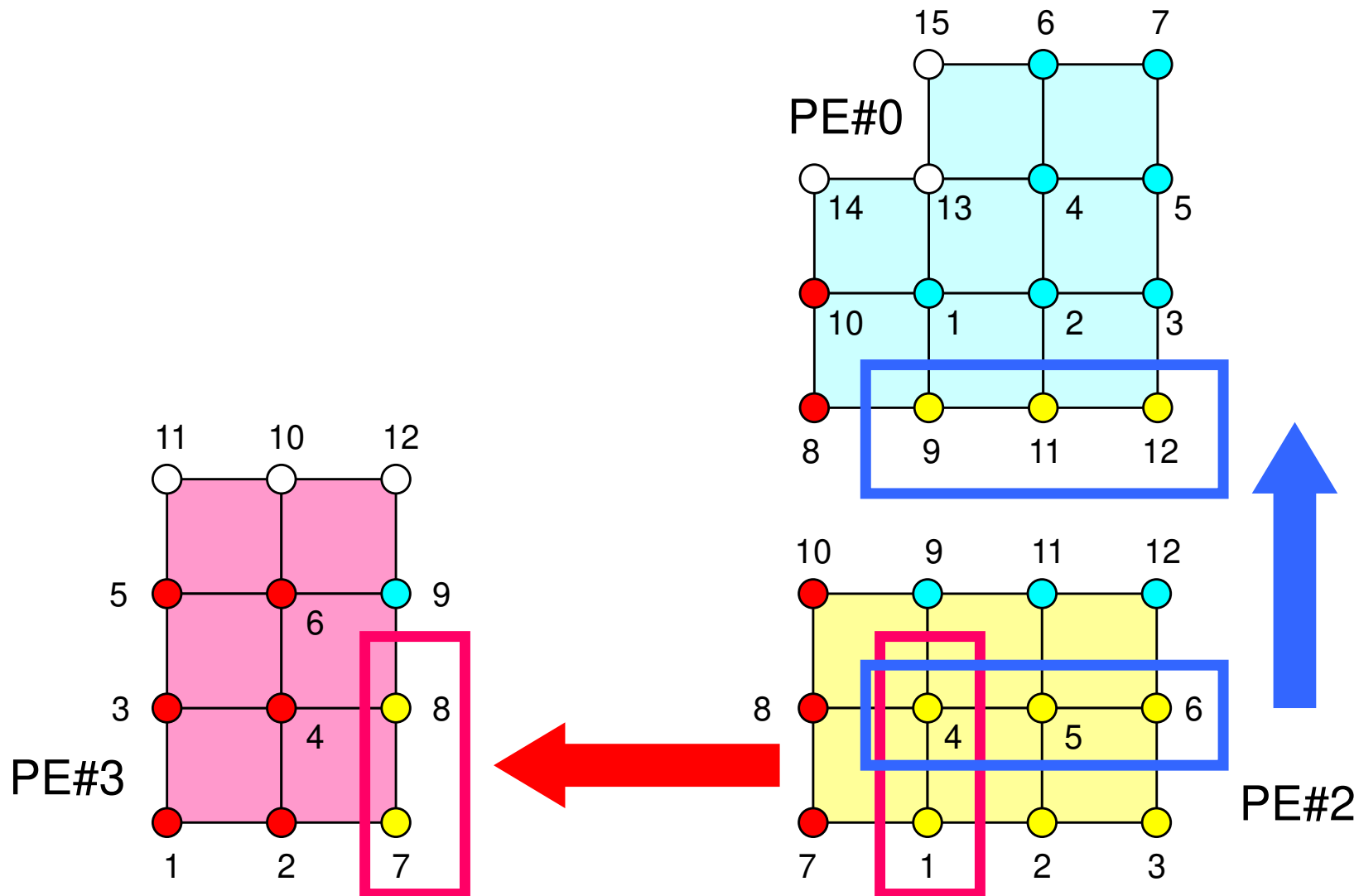

# External Nodes (外点) : RECEIVE

PE#2 : receive information for “external nodes”

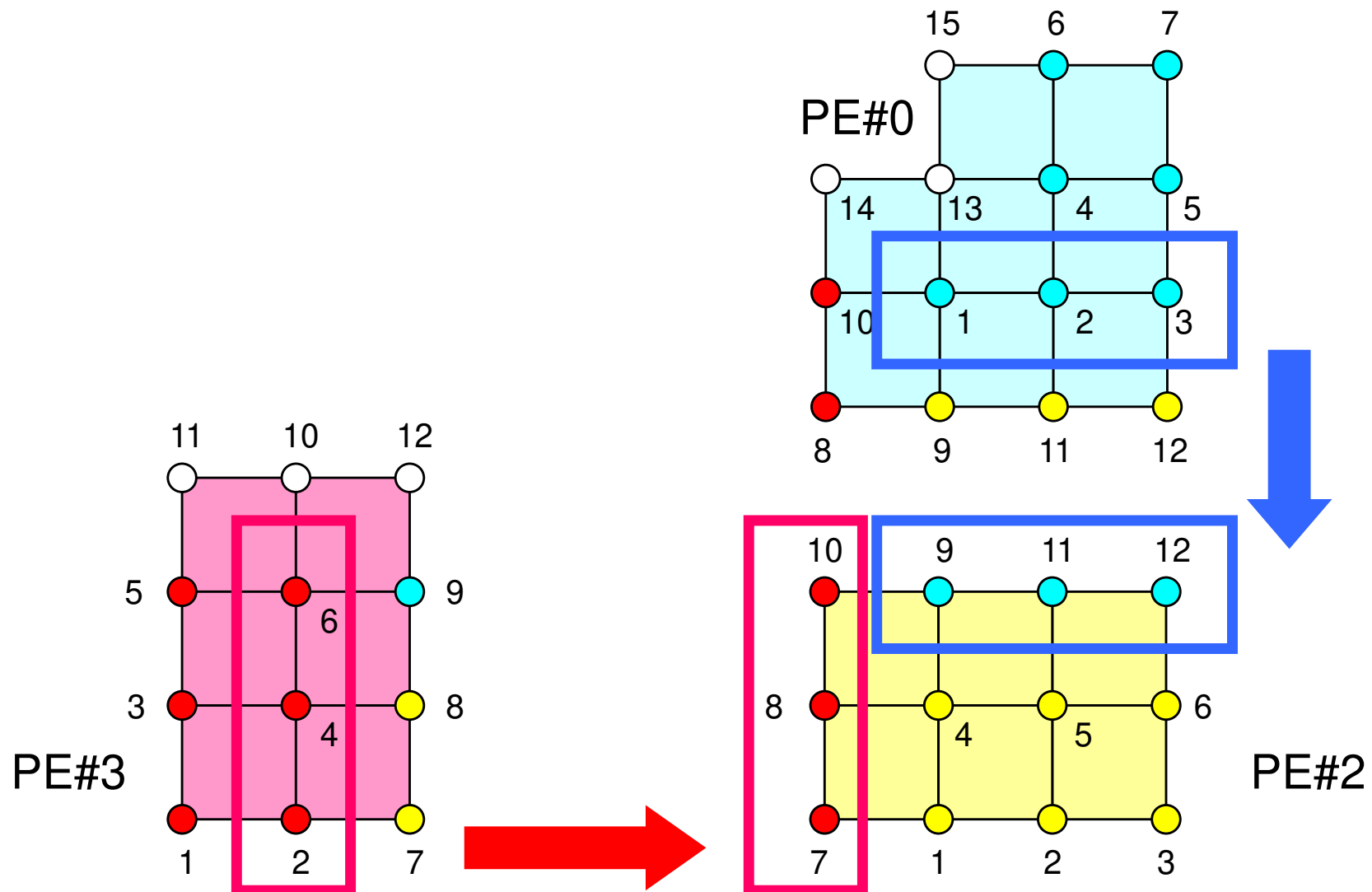

# Neighbors

pc.0

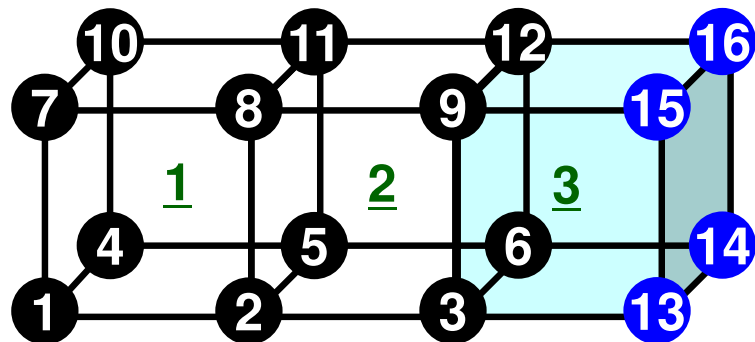

pc.1

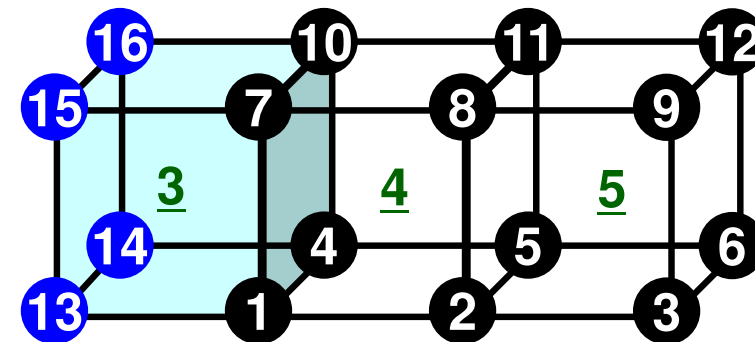

0	1	1	16	12
1	0	0.00	0.00	0.00
2	0	1.00	0.00	0.00
3	0	2.00	0.00	0.00
4	0	0.00	1.00	0.00
5	0	1.00	1.00	0.00
6	0	2.00	1.00	0.00
7	0	0.00	0.00	1.00
8	0	1.00	0.00	1.00
9	0	2.00	0.00	1.00
10	0	0.00	1.00	1.00
11	0	1.00	1.00	1.00
12	0	2.00	1.00	1.00
1	1	3.00	0.00	0.00
4	1	3.00	1.00	0.00
7	1	3.00	0.00	1.00
10	1	3.00	1.00	1.00

1	ID of PE	NEIBPETOT: # neighbors	NEIBPE(neib): ID of neighbors
16	12		
1	1	3.00	0.00 0.00
2	1	4.00	0.00 0.00
3	1	5.00	0.00 0.00
4	1	3.00	1.00 0.00
5	1	4.00	1.00 0.00
6	1	5.00	1.00 0.00
7	1	3.00	0.00 1.00
8	1	4.00	0.00 1.00
9	1	5.00	0.00 1.00
10	1	3.00	1.00 1.00
11	1	4.00	1.00 1.00
12	1	5.00	1.00 1.00
3	0	2.00	0.00 0.00
6	0	2.00	1.00 0.00
9	0	2.00	0.00 1.00
12	0	2.00	1.00 1.00

# Local Numbering: Nodes

- Local node ID starts from “1” in each PE
  - Same program for 1-CPU can be used: SPMD
  - Local element ID also starts from “1”
- Numbering: Internal -> External Points
- Double Numbering
  - Local node ID at its “home” PE: `NODE_ID (i, 1)`
  - ID of “home” PE: `NODE_ID (i, 2)`
- **Suitable for Adaptive Mesh Refinement and Dynamic Load Balancing (next page)**

# Supersonic Flow around a Sphere

Ideal Gas,  $M=1.40$ , Uniform Flow,  $Re=10^6$   
before/after Dynamic Load Balancing

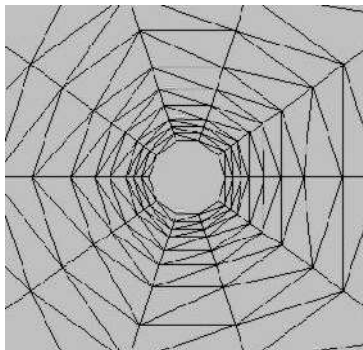
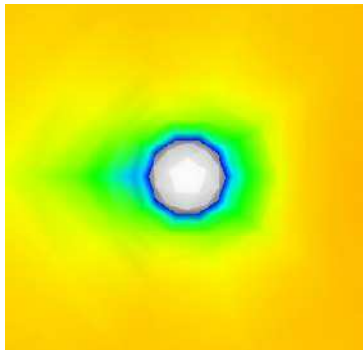

**Initial Grid**

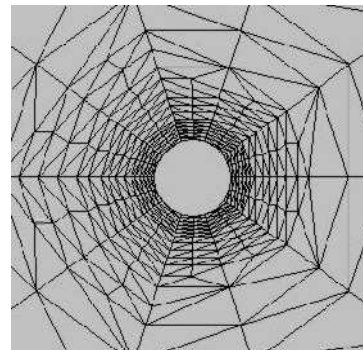
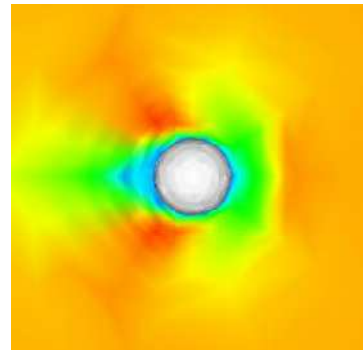

**1-Lev. Adapted**

before    after

793        652

696        650

668        652

448        651

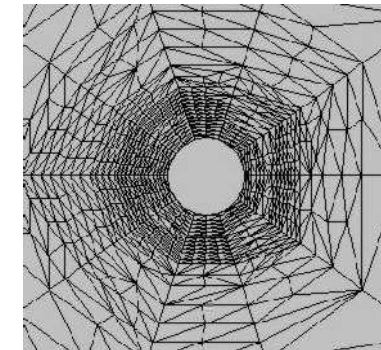
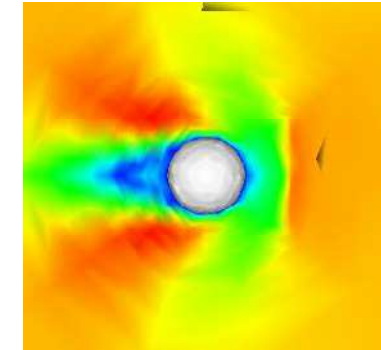

**2-Lev. Adapted**

before    after

3834        2527

2769        2526

2703        2522

1390        2524

PE0	137	-
PE1	137	-
PE2	136	-
PE3	136	-

# Internal, External Nodes

pc.0

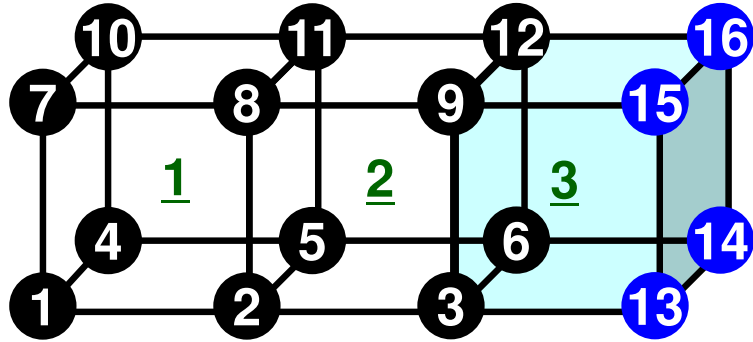

pc.1

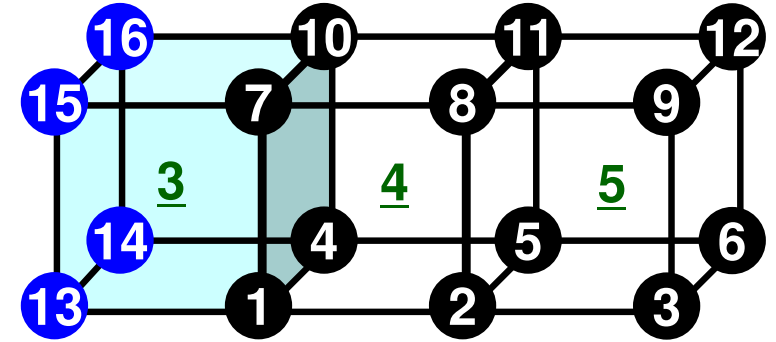

0				
1				
1				
16		12		
1	0	0.00	0.00	0.00
2	0	1.00	0.00	0.00
3	0	2.00	0.00	0.00
4	0	0.00	1.00	0.00
5	0	1.00	1.00	0.00
6	0	2.00	1.00	0.00
7	0	0.00	0.00	1.00
8	0	1.00	0.00	1.00
9	0	2.00	0.00	1.00
10	0	0.00	1.00	1.00
11	0	1.00	1.00	1.00
12	0	2.00	1.00	1.00
1	1	3.00	0.00	0.00
4	1	3.00	1.00	0.00
7	1	3.00	0.00	1.00
10	1	3.00	1.00	1.00

1				
1				
0				
16		12 (Node #: Total, Internal)		
1	1	3.00	0.00	0.00
2	1	4.00	0.00	0.00
3	1	5.00	0.00	0.00
4	1	3.00	1.00	0.00
5	1	4.00	1.00	0.00
6	1	5.00	1.00	0.00
7	1	3.00	0.00	1.00
8	1	4.00	0.00	1.00
9	1	5.00	0.00	1.00
10	1	3.00	1.00	1.00
11	1	4.00	1.00	1.00
12	1	5.00	1.00	1.00
3	0	2.00	0.00	0.00
6	0	2.00	1.00	0.00
9	0	2.00	0.00	1.00
12	0	2.00	1.00	1.00

# Local Numbering: Nodes

pc.0

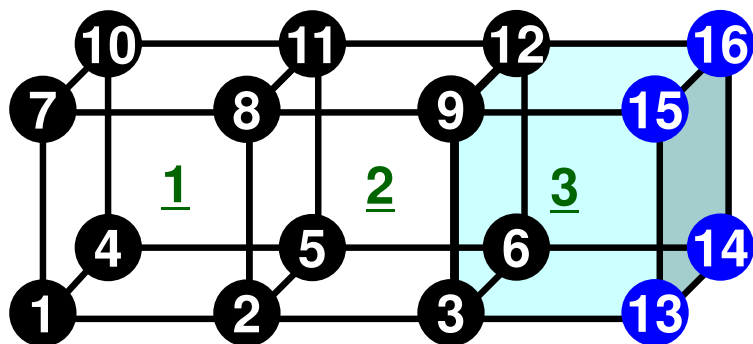

pc.1

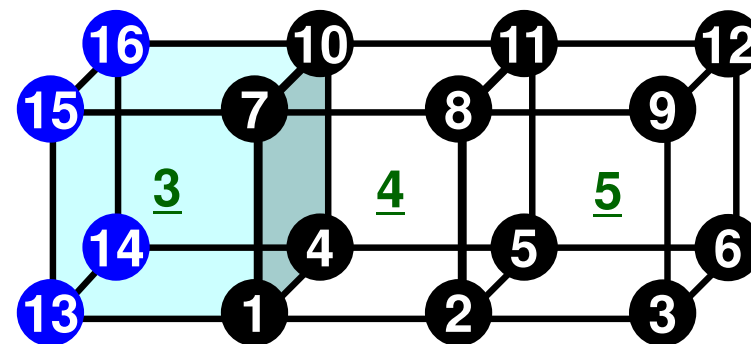

0					
1					
1					
16	12				
1	0	0.00	0.00	0.00	①
2	0	1.00	0.00	0.00	②
3	0	2.00	0.00	0.00	③
4	0	0.00	1.00	0.00	④
5	0	1.00	1.00	0.00	⑤
6	0	2.00	1.00	0.00	⑥
7	0	0.00	0.00	1.00	⑦
8	0	1.00	0.00	1.00	⑧
9	0	2.00	0.00	1.00	⑨
10	0	0.00	1.00	1.00	⑩
11	0	1.00	1.00	1.00	⑪
12	0	2.00	1.00	1.00	⑫
1	1	3.00	0.00	0.00	⑬
4	1	3.00	1.00	0.00	⑭
7	1	3.00	0.00	1.00	⑮
10	1	3.00	1.00	1.00	⑯

Local ID, "Home" PE, Coordinates

1					
1					
0					
16	12				
1	1	3.00	0.00	0.00	①
2	1	4.00	0.00	0.00	②
3	1	5.00	0.00	0.00	③
4	1	3.00	1.00	0.00	④
5	1	4.00	1.00	0.00	⑤
6	1	5.00	1.00	0.00	⑥
7	1	3.00	0.00	1.00	⑦
8	1	4.00	0.00	1.00	⑧
9	1	5.00	0.00	1.00	⑨
10	1	3.00	1.00	1.00	⑩
11	1	4.00	1.00	1.00	⑪
12	1	5.00	1.00	1.00	⑫
3	0	2.00	0.00	0.00	⑬
6	0	2.00	1.00	0.00	⑭
9	0	2.00	0.00	1.00	⑮
12	0	2.00	1.00	1.00	⑯

Local ID, "Home" PE, Coordinates

# Local Numbering: Nodes

pc.0

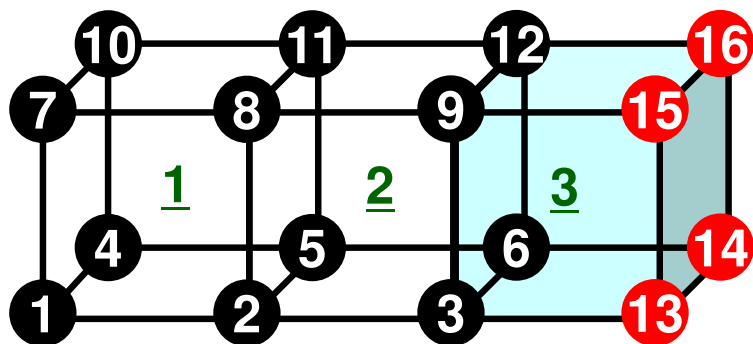

pc.1

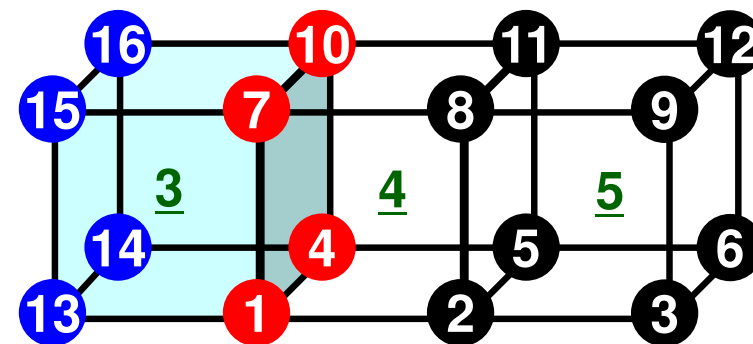

0					
1					
1					
16	12				
1	0	0.00	0.00	0.00	①
2	0	1.00	0.00	0.00	②
3	0	2.00	0.00	0.00	③
4	0	0.00	1.00	0.00	④
5	0	1.00	1.00	0.00	⑤
6	0	2.00	1.00	0.00	⑥
7	0	0.00	0.00	1.00	⑦
8	0	1.00	0.00	1.00	⑧
9	0	2.00	0.00	1.00	⑨
10	0	0.00	1.00	1.00	⑩
11	0	1.00	1.00	1.00	⑪
12	0	2.00	1.00	1.00	⑫
1	1	3.00	0.00	0.00	⑬
4	1	3.00	1.00	0.00	⑭
7	1	3.00	0.00	1.00	⑮
10	1	3.00	1.00	1.00	⑯

Local ID, "Home" PE, Coordinates

1					
1					
0					
16	12				
1	1	3.00	0.00	0.00	①
2	1	4.00	0.00	0.00	②
3	1	5.00	0.00	0.00	③
4	1	3.00	1.00	0.00	④
5	1	4.00	1.00	0.00	⑤
6	1	5.00	1.00	0.00	⑥
7	1	3.00	0.00	1.00	⑦
8	1	4.00	0.00	1.00	⑧
9	1	5.00	0.00	1.00	⑨
10	1	3.00	1.00	1.00	⑩
11	1	4.00	1.00	1.00	⑪
12	1	5.00	1.00	1.00	⑫
3	0	2.00	0.00	0.00	⑬
6	0	2.00	1.00	0.00	⑭
9	0	2.00	0.00	1.00	⑮
12	0	2.00	1.00	1.00	⑯

Local ID, "Home" PE, Coordinates



# Local Numbering: Nodes

pc.0

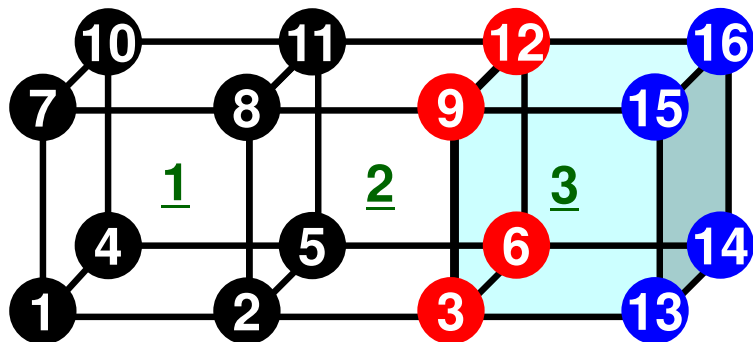

pc.1

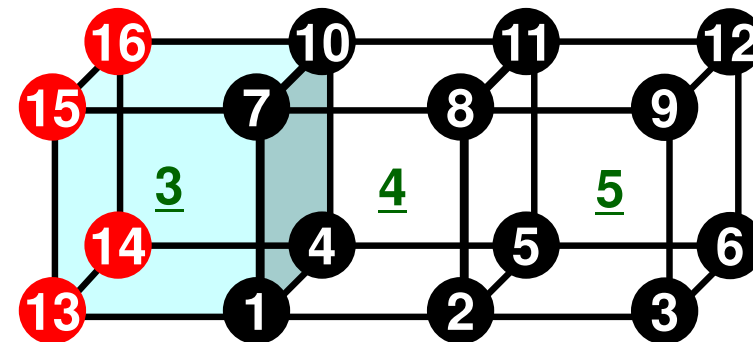

0					
1					
1					
16	12				
1	0	0.00	0.00	0.00	①
2	0	1.00	0.00	0.00	②
3	0	2.00	0.00	0.00	③
4	0	0.00	1.00	0.00	④
5	0	1.00	1.00	0.00	⑤
6	0	2.00	1.00	0.00	⑥
7	0	0.00	0.00	1.00	⑦
8	0	1.00	0.00	1.00	⑧
9	0	2.00	0.00	1.00	⑨
10	0	0.00	1.00	1.00	⑩
11	0	1.00	1.00	1.00	⑪
12	0	2.00	1.00	1.00	⑫
1	1	3.00	0.00	0.00	⑬
4	1	3.00	1.00	0.00	⑭
7	1	3.00	0.00	1.00	⑮
10	1	3.00	1.00	1.00	⑯

Local ID, "Home" PE, Coordinates

1					
1					
0					
16	12				
1	1	3.00	0.00	0.00	①
2	1	4.00	0.00	0.00	②
3	1	5.00	0.00	0.00	③
4	1	3.00	1.00	0.00	④
5	1	4.00	1.00	0.00	⑤
6	1	5.00	1.00	0.00	⑥
7	1	3.00	0.00	1.00	⑦
8	1	4.00	0.00	1.00	⑧
9	1	5.00	0.00	1.00	⑨
10	1	3.00	1.00	1.00	⑩
11	1	4.00	1.00	1.00	⑪
12	1	5.00	1.00	1.00	⑫
3	0	2.00	0.00	0.00	⑬
6	0	2.00	1.00	0.00	⑭
9	0	2.00	0.00	1.00	⑮
12	0	2.00	1.00	1.00	⑯

Local ID, "Home" PE, Coordinates

# Local Numbering: Nodes

pc.0

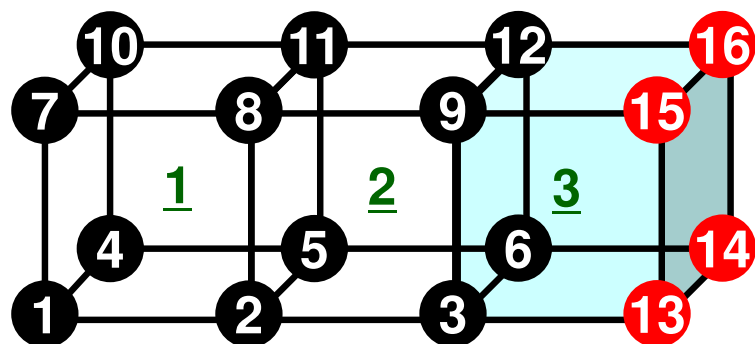

pc.1

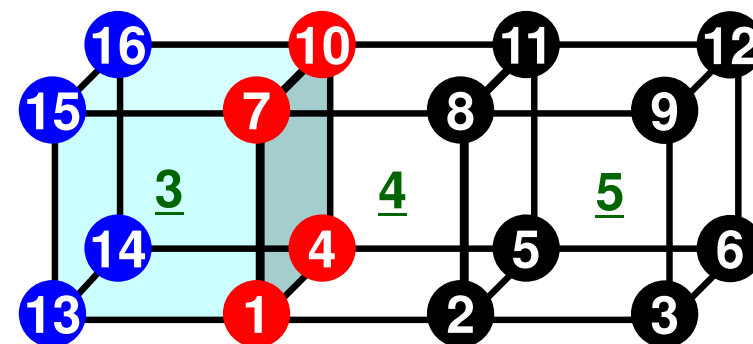

0					
1					
1					
16	12				
1	0	0.00	0.00	0.00	①
2	0	1.00	0.00	0.00	②
3	0	2.00	0.00	0.00	③
4	0	0.00	1.00	0.00	④
5	0	1.00	1.00	0.00	⑤
6	0	2.00	1.00	0.00	⑥
7	0	0.00	0.00	1.00	⑦
8	0	1.00	0.00	1.00	⑧
9	0	2.00	0.00	1.00	⑨
10	0	0.00	1.00	1.00	⑩
11	0	1.00	1.00	1.00	⑪
12	0	2.00	1.00	1.00	⑫
1	1	3.00	0.00	0.00	⑬
4	1	3.00	1.00	0.00	⑭
7	1	3.00	0.00	1.00	⑮
10	1	3.00	1.00	1.00	⑯

Local ID, "Home" PE,

Coordinates

1					
1					
0					
16	12				
1	1	3.00	0.00	0.00	①
2	1	4.00	0.00	0.00	②
3	1	5.00	0.00	0.00	③
4	1	3.00	1.00	0.00	④
5	1	4.00	1.00	0.00	⑤
6	1	5.00	1.00	0.00	⑥
7	1	3.00	0.00	1.00	⑦
8	1	4.00	0.00	1.00	⑧
9	1	5.00	0.00	1.00	⑨
10	1	3.00	1.00	1.00	⑩
11	1	4.00	1.00	1.00	⑪
12	1	5.00	1.00	1.00	⑫
3	0	2.00	0.00	0.00	⑬
6	0	2.00	1.00	0.00	⑭
9	0	2.00	0.00	1.00	⑮
12	0	2.00	1.00	1.00	⑯

Local ID, "Home" PE,

Coordinates

Only "local" ID's (numbers enclosed in circles) are used in the program



# Local Numbering: Elements

pc.0

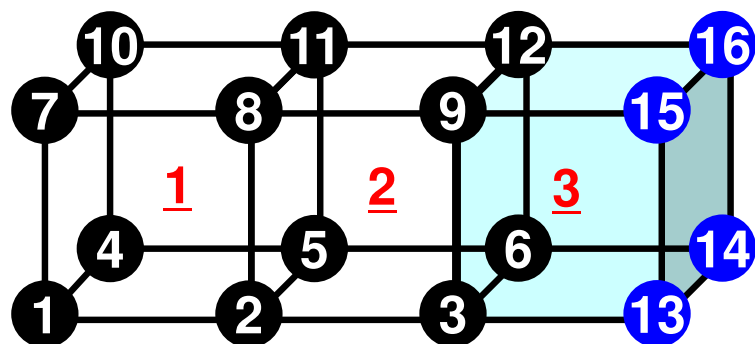

pc.1

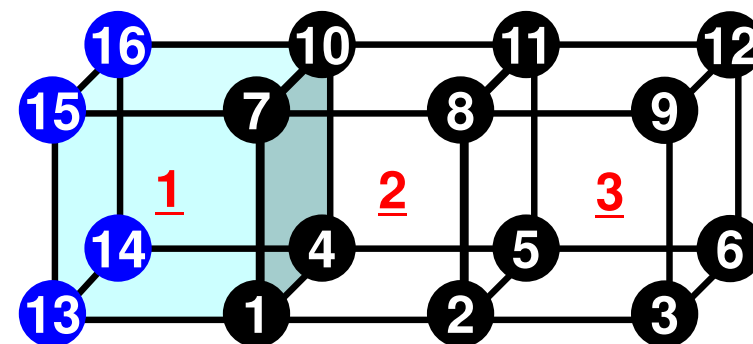

3	3										
361	361	361									
1	0		1	1	2	5	4	7	8	11	10
2	0		1	2	3	6	5	8	9	12	11
3	0		1	3	13	14	6	9	15	16	12
1	2	3									

3	2	(Element #: All, Local)									
361	361	361									
3	0		1	13	1	4	14	15	7	10	16
1	1		1	1	2	5	4	7	8	11	10
2	1		1	2	3	6	5	8	9	12	11
2	3										

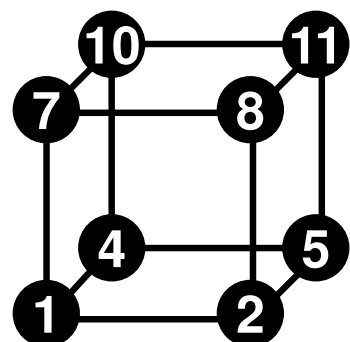

- “Home” PE of Element
  - Defined by “home” of 8 nodes
  - If all of 8 nodes are internal pts., “home” of the element is that of 8 nodes.
  - If external nodes are included, the smallest number of ID of “home” of the nodes is selected.
  - In this case, “home” PE’s of elements in overlapped region are all “0”.



# Local Numbering: Elements

pc.0

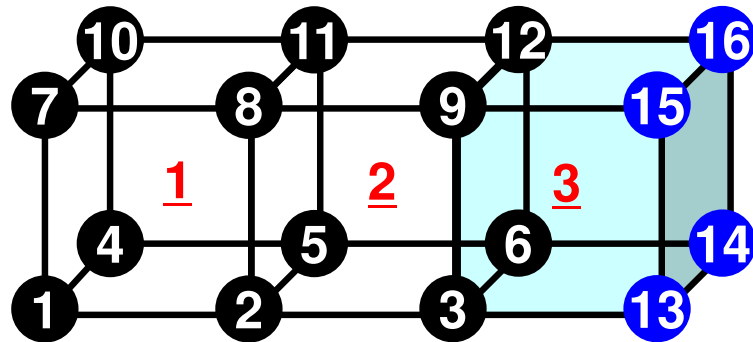

pc.1

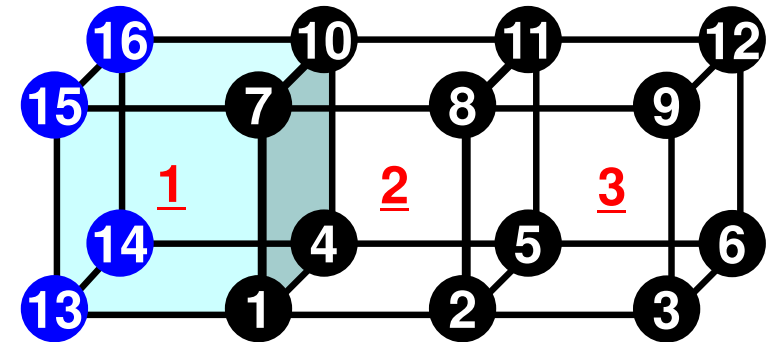

<u>3</u>	3																		
361	361	361																	
1	0	1	1	2	5	4	7	8	11	10	<u>1</u>								
2	0	1	2	3	6	5	8	9	12	11	<u>2</u>								
3	0	1	3	13	14	6	9	15	16	12	<u>3</u>								
1	2	3																	

<u>3</u>	2																		
361	361	361																	
3	0	1	13	1	4	14	15	7	10	16	<u>1</u>								
1	1	1	1	2	5	4	7	8	11	10	<u>2</u>								
2	1	1	2	3	6	5	8	9	12	11	<u>3</u>								
2	3																		

- Double Numbering for Element
  - Local ID at “home” PE: **ELEM\_ID (i, 1)**
  - ID of “home” PE: **ELEM\_ID (i, 2)**
- Material ID
- 8 Nodes
- Underlined local ID is used in the program

# Local Numbering: Elements

pc.0

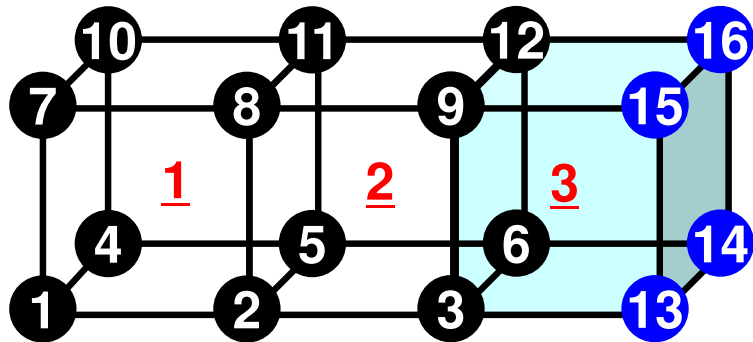

pc.1

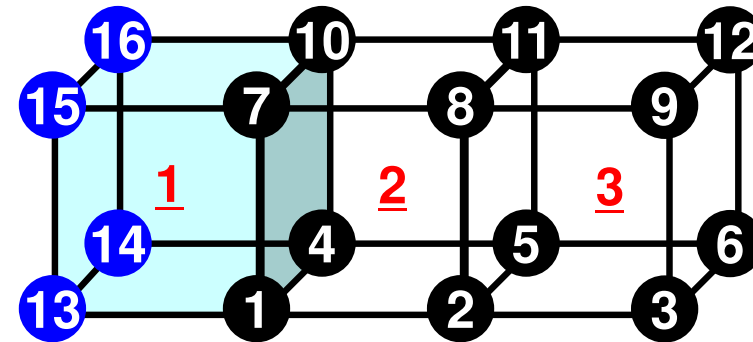

3	<u>3</u>												
361	361	361											
1	0	1	1	2	5	4	7	8	11	10	1		
2	0	1	2	3	6	5	8	9	12	11	<u>2</u>		
3	0	1	3	13	14	6	9	15	16	12	<u>3</u>		
1	2	3											

3	<u>2</u>												
361	361	361											
3	0	1	13	1	4	14	15	7	10	16	1		
1	1	1	1	2	5	4	7	8	11	10	<u>2</u>		
2	1	1	2	3	6	5	8	9	12	11	<u>3</u>		
2	3												

- pc.0
  - 1, 2, 3 are “Local Elements” (“Home Elements”)
- pc.1
  - 2, 3 are “Local Elements” (“Home Elements”)

# Communication Tables

pc.0

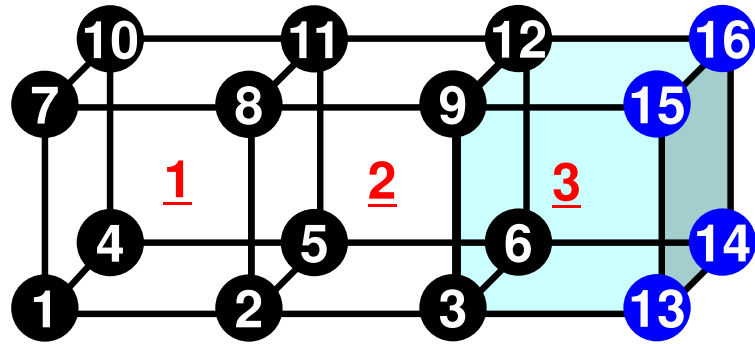

pc.1

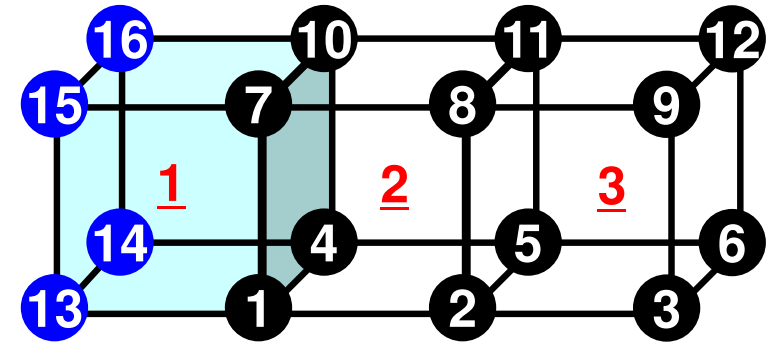

4  
13  
14  
15  
16  
4  
3  
6  
9  
12

4  
13  
14  
15  
16  
4  
1  
4  
7  
10



# PE-to-PE Communication

## Generalized Communication Tables

- “Communication” in parallel FEM means obtaining information of “external points” from their “home” PE’s
- “Communication Tables” describe relationship of “external points” among PE’s
  - Send/Export, Recv/Import
- Sending information of “boundary points”
- Receiving information of “external points”

# Generalized Comm. Table: Send

- Neighbors
  - NEIBPETOT, NEIBPE(neib)
- Message size for each neighbor
  - export\_index(neib), neib= 0, NEIBPETOT
- ID of **boundary** points
  - export\_item(k), k= 1, export\_index(NEIBPETOT)
- Messages to each neighbor
  - SENDbuf(k), k= 1, export\_index(NEIBPETOT)

# Communication Table (Send/Export)

pc.0

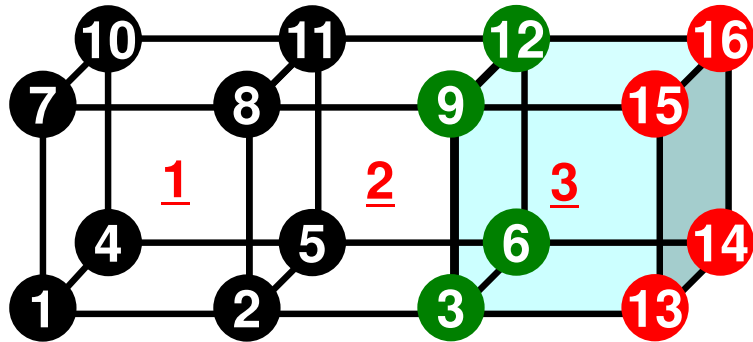

pc.1

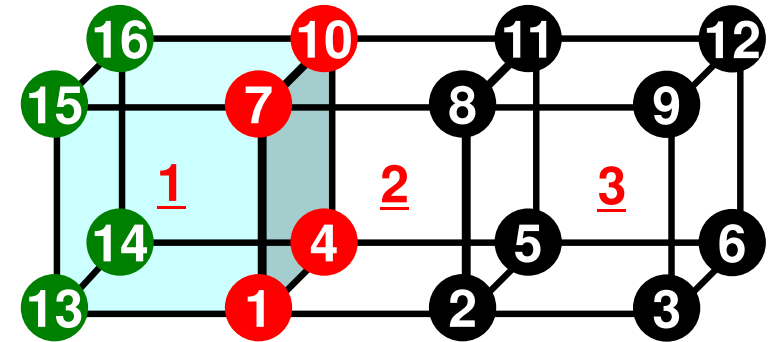

```

4
13
14
15
16
4
3
6
9
12

```

```

4
13
14
15
16
4
1
4
7
10

```

```

export_index(neib)
export_item

```

- `export_index` Size of Messages sent to Each Neighbor
  - # Neighbors= 1 in this case
- `export_item` Local ID of boundary points

# Communication Table (Send/Export)

pc.0

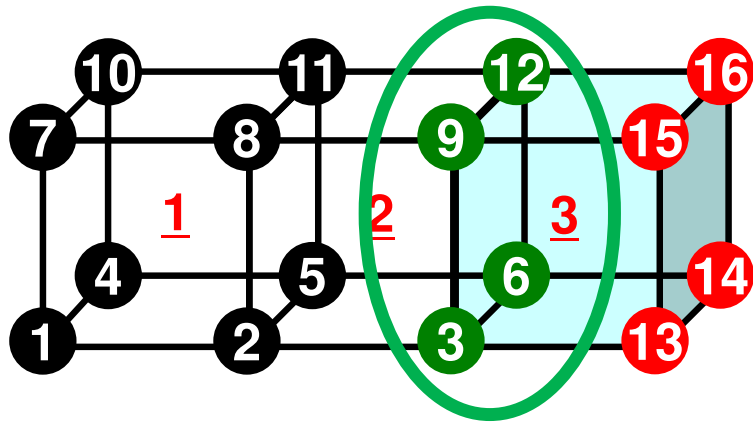

```

4
13
14
15
16
4
3
6
9
12

```

pc.1

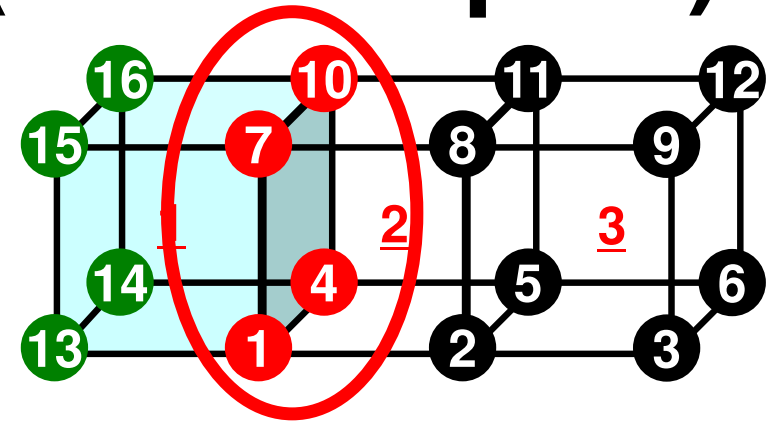

```

4
13
14
15
16
4
1
4
7
10
export_index(neib)
export_item

```

- `export_index` Size of Messages sent to Each Neighbor
  - # Neighbors= 1 in this case
- `export_item` Local ID of boundary points

# SEND: MPI\_Isend/Irecv/Waitall Fortran

**SENDbuf**

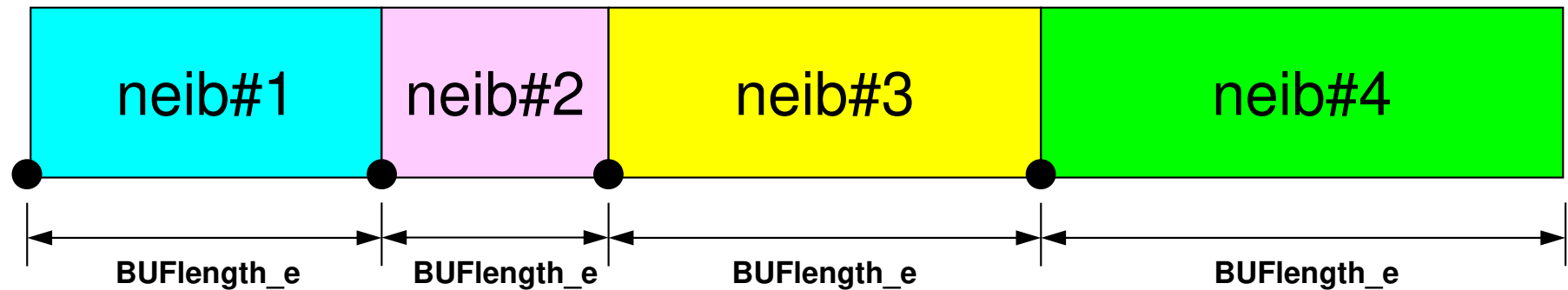

export\_index(0)+1    export\_index(1)+1    export\_index(2)+1    export\_index(3)+1    export\_index(4)

```
do neib= 1, NEIBPETOT
  do k= export_index(neib-1)+1, export_index(neib)
    kk= export_item(k)
    SENDbuf(k) = VAL(kk)
  enddo
enddo
```

Copied to sending buffers

```
do neib= 1, NEIBPETOT
  iS_e = export_index(neib-1) + 1
  iE_e = export_index(neib )
  BUFlength_e = iE_e + 1 - iS_e
```

```
call MPI_ISEND
&      (SENDbuf(iS_e), BUFlength_e, MPI_INTEGER, NEIBPE(neib), 0, &
&      MPI_COMM_WORLD, request_send(neib), ierr)
```

enddo

```
call MPI_WAITALL (NEIBPETOT, request_send, stat_recv, ierr)
```

# Generalized Comm. Table: Receive

- Neighbors
  - NEIBPETOT, NEIBPE(neib)
- Message size for each neighbor
  - import\_index(neib), neib= 0, NEIBPETOT
- ID of **external** points
  - import\_item(k), k= 1, import\_index(NEIBPETOT)
- Messages from each neighbor
  - RECVbuf(k), k= 1, import\_index(NEIBPETOT)

# Communication Table (Recv/Import)

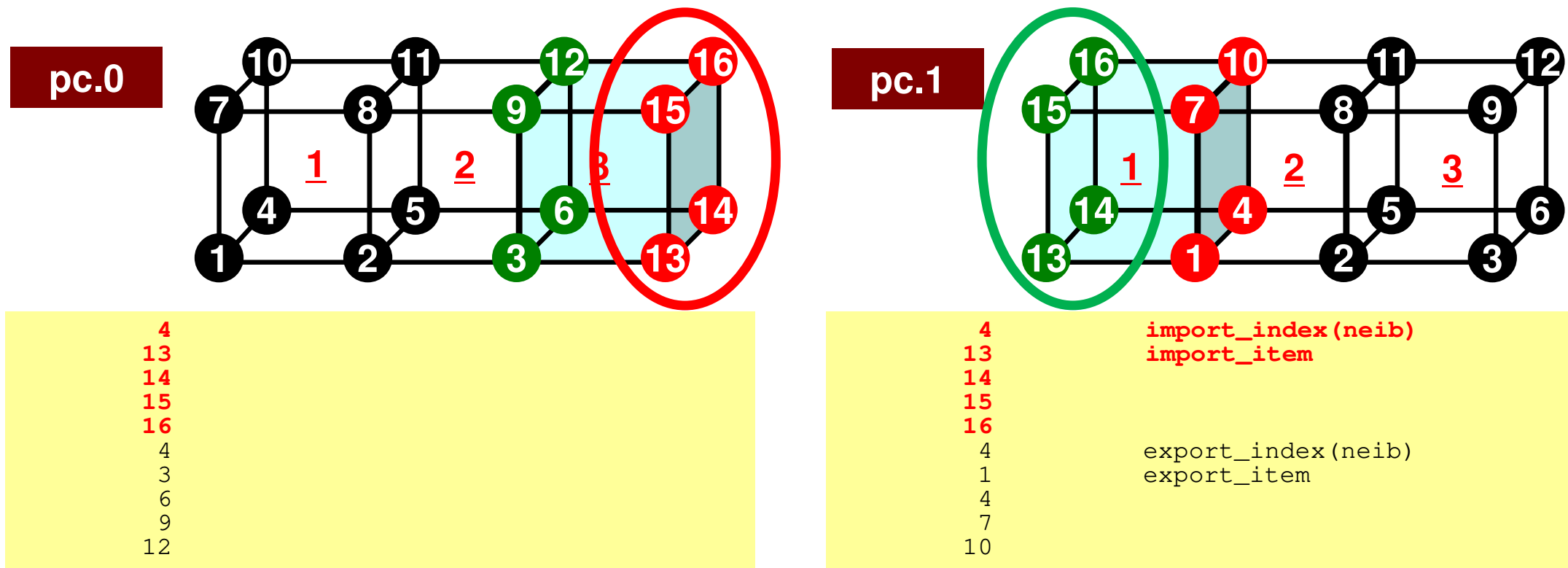

- `import_index` Size of Messages recv. from Each Neighbor  
– # Neighbors= 1 in this case
- `import_item` Local ID of external points

# Communication Table (Recv/Import)

pc.0

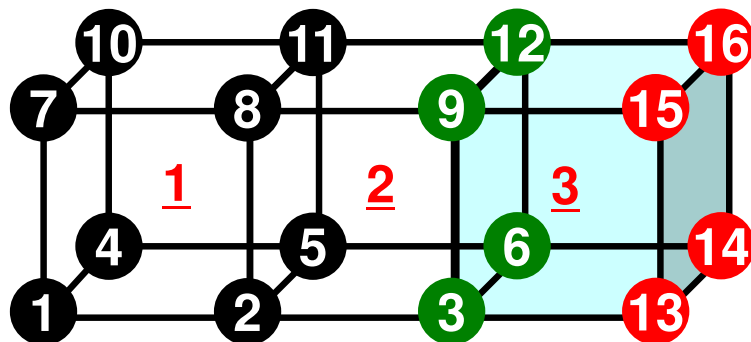

```

4
13
14
15
16
4
3
6
9
12

```

pc.1

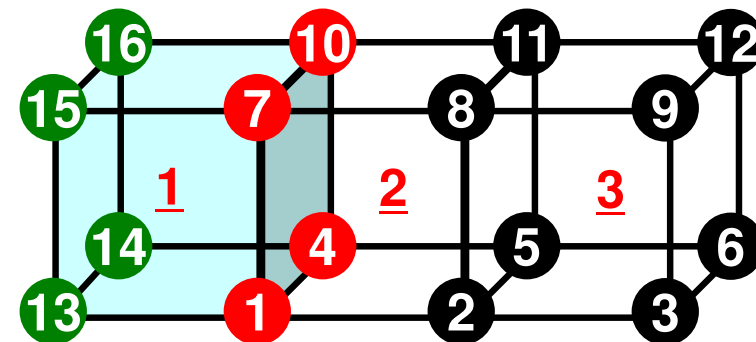

```

4
13
14
15
16
4
1
4
7
10
import_index(neib)
import_item

export_index(neib)
export_item

```

- `import_index` Size of Messages recv. from Each Neighbor
  - # Neighbors= 1 in this case
- `import_item` Local ID of external points



# Communication Table (Recv/Import)

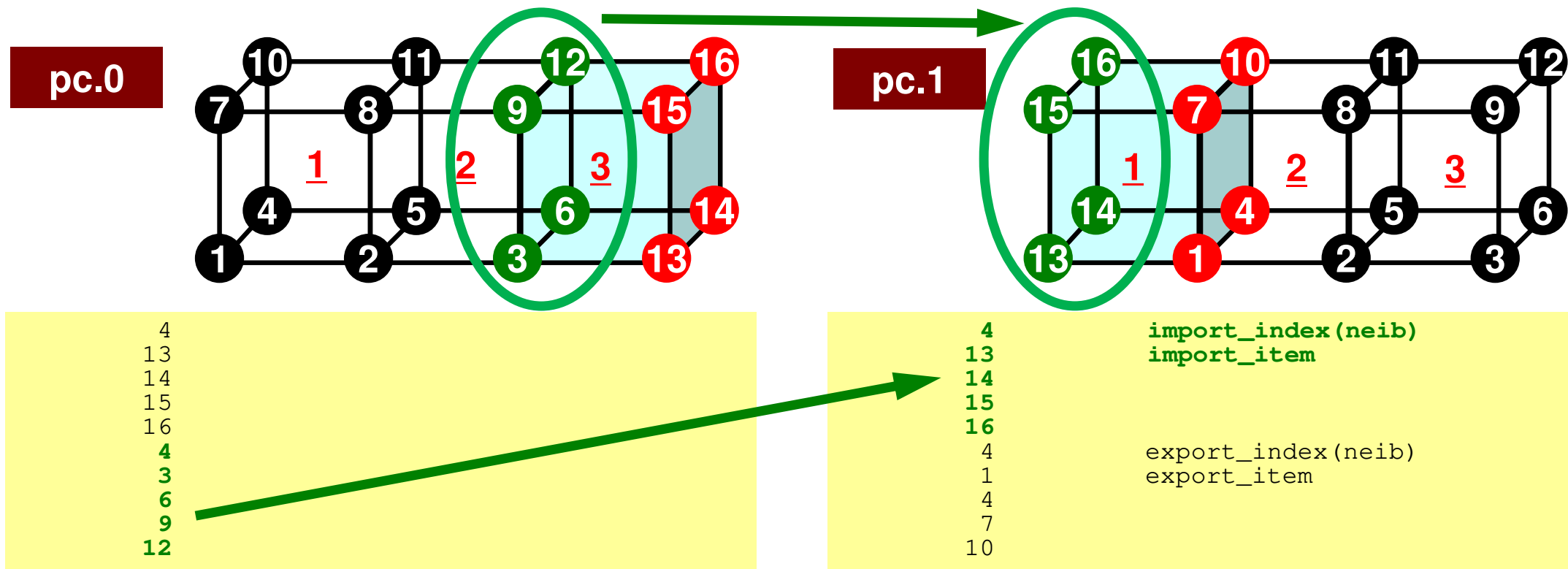

- `import_index` Size of Messages recv. from Each Neighbor  
– # Neighbors= 1 in this case
- `import_item` Local ID of external points

# Communication Table (Recv/Import)

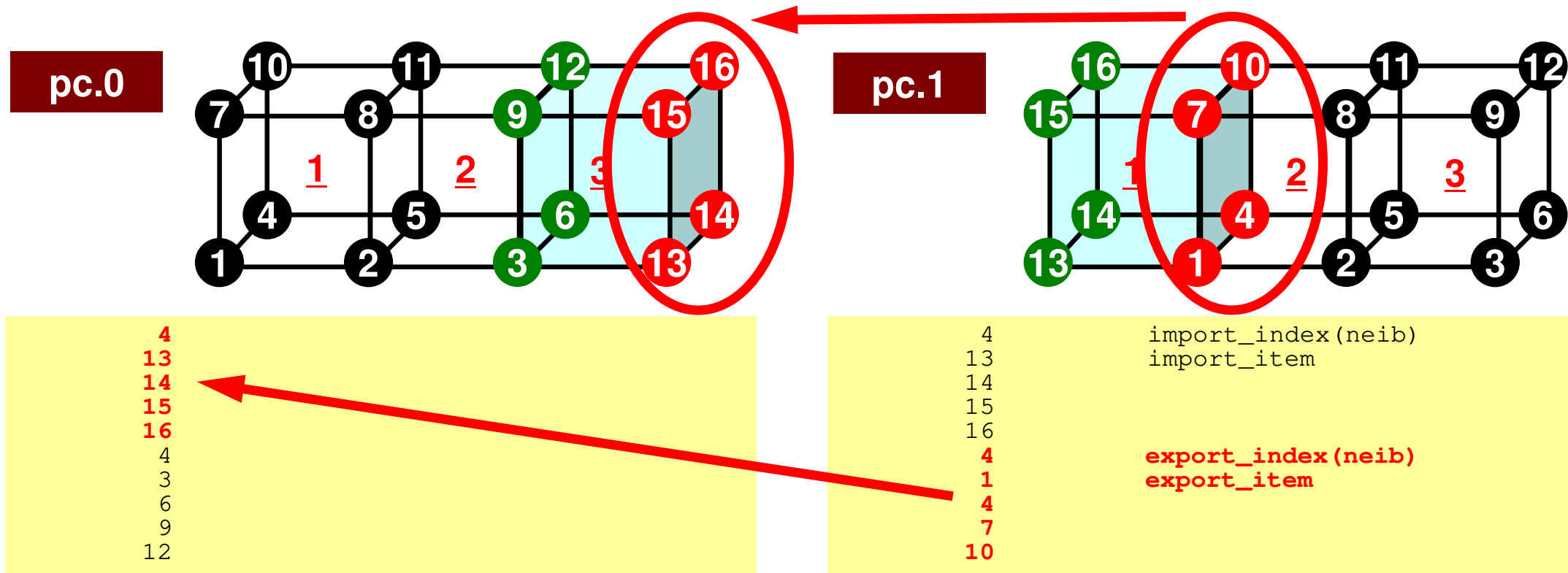

- `import_index` Size of Messages recv. from Each Neighbor  
– # Neighbors= 1 in this case
- `import_item` Local ID of external points

# RECV: MPI\_Isend/Irecv/Waitall Fortran

```

do neib= 1, NEIBPETOT
  iS_i= import_index(neib-1) + 1
  iE_i= import_index(neib  )
  BUFlength_i= iE_i + 1 - iS_i

  call MPI_IRECV
&      (RECVbuf(iS_i), BUFlength_i, MPI_INTEGER, NEIBPE(neib), 0, &
&      MPI_COMM_WORLD, request_recv(neib), ierr)
enddo

call MPI_WAITALL (NEIBPETOT, request_recv, stat_recv, ierr)

do neib= 1, NEIBPETOT
  do k= import_index(neib-1)+1, import_index(neib)
    kk= import_item(k)
    VAL(kk)= RECVbuf(k)
  enddo
enddo

```

Copied from receiving buffer

**RECVbuf**

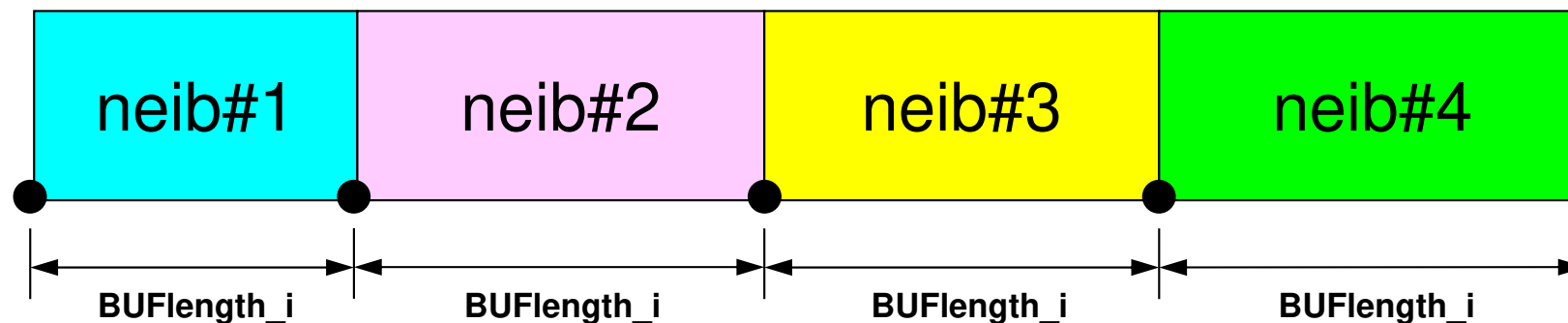

import\_index(0)+1    import\_index(1)+1    import\_index(2)+1    import\_index(3)+1    import\_index(4)

# Node-based Partitioning

internal nodes - elements - external nodes

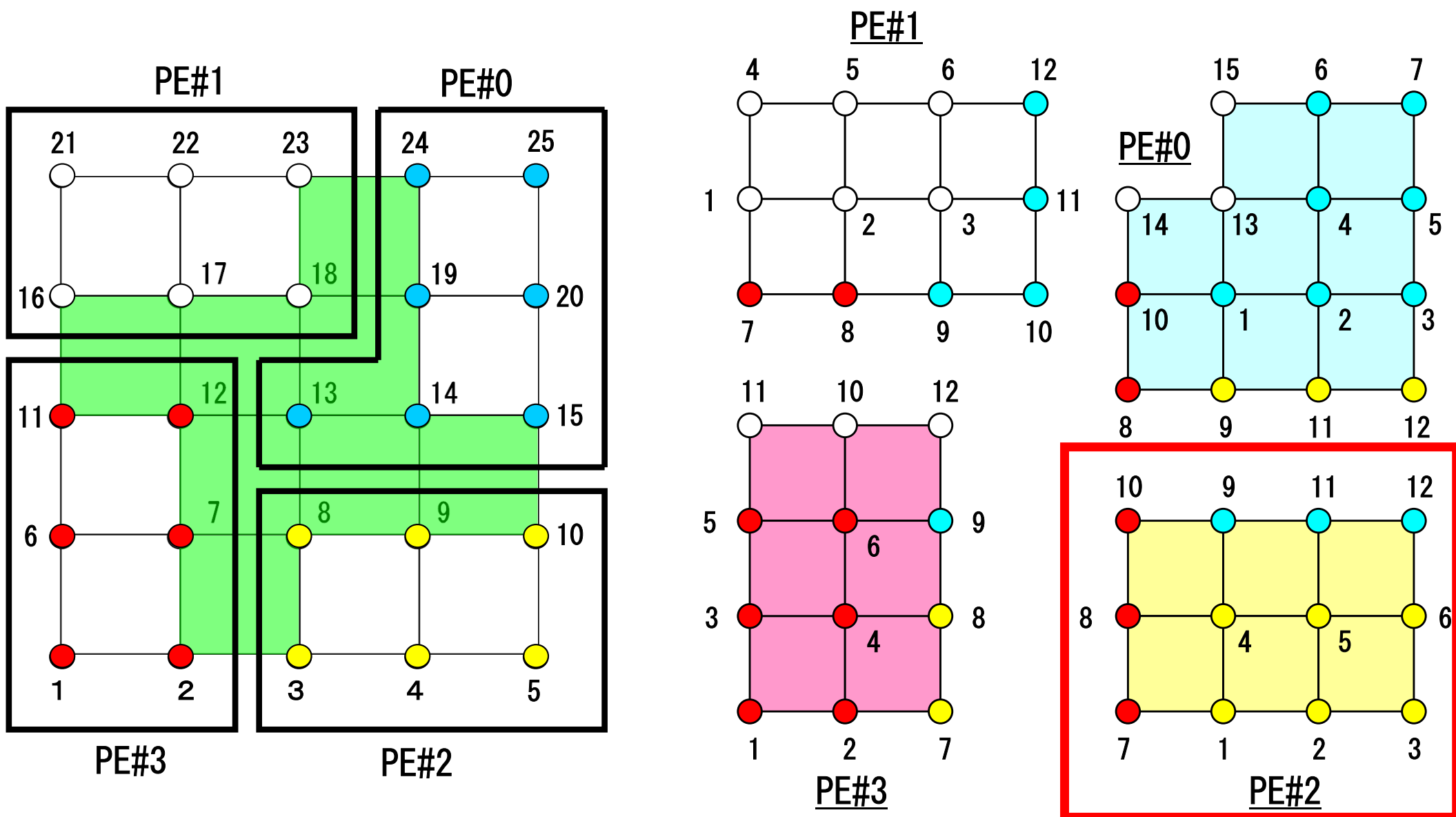

# Description of Distributed Local Data

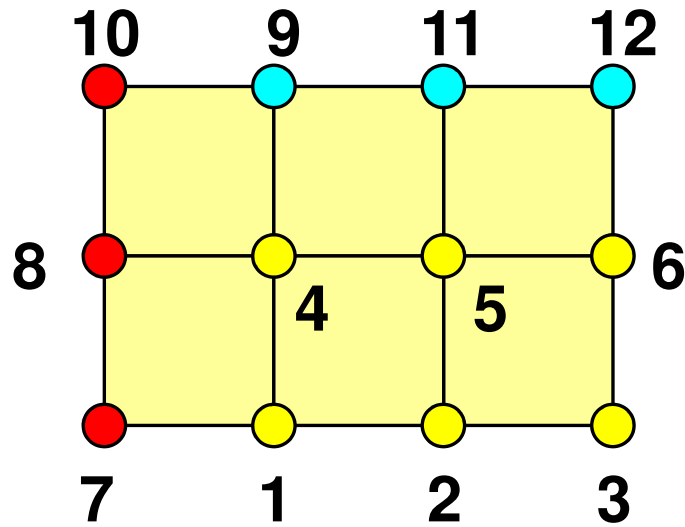

- **Internal/External Points**
  - Numbering: Starting from internal pts, then external pts after that
- **Neighbors**
  - Shares overlapped meshes
  - Number and ID of neighbors
- **External Points**
  - From where, how many, and which external points are received/imported ?
- **Boundary Points**
  - To where, how many and which boundary points are sent/exported ?

# Boundary Nodes (境界点) : SEND

PE#2 : send information on “boundary nodes”

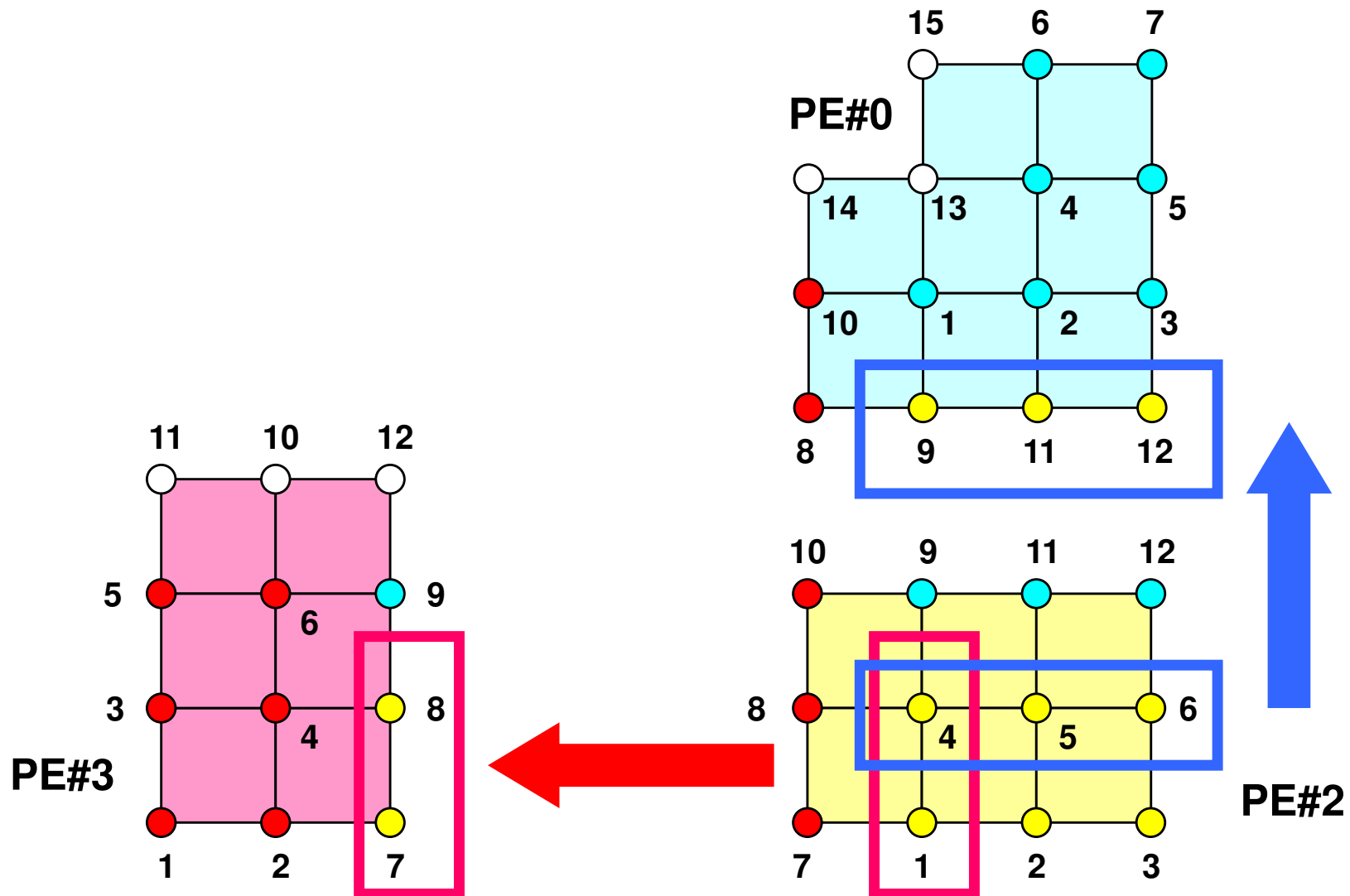

# External Nodes (外点) : RECEIVE

PE#2 : receive information for “external nodes”

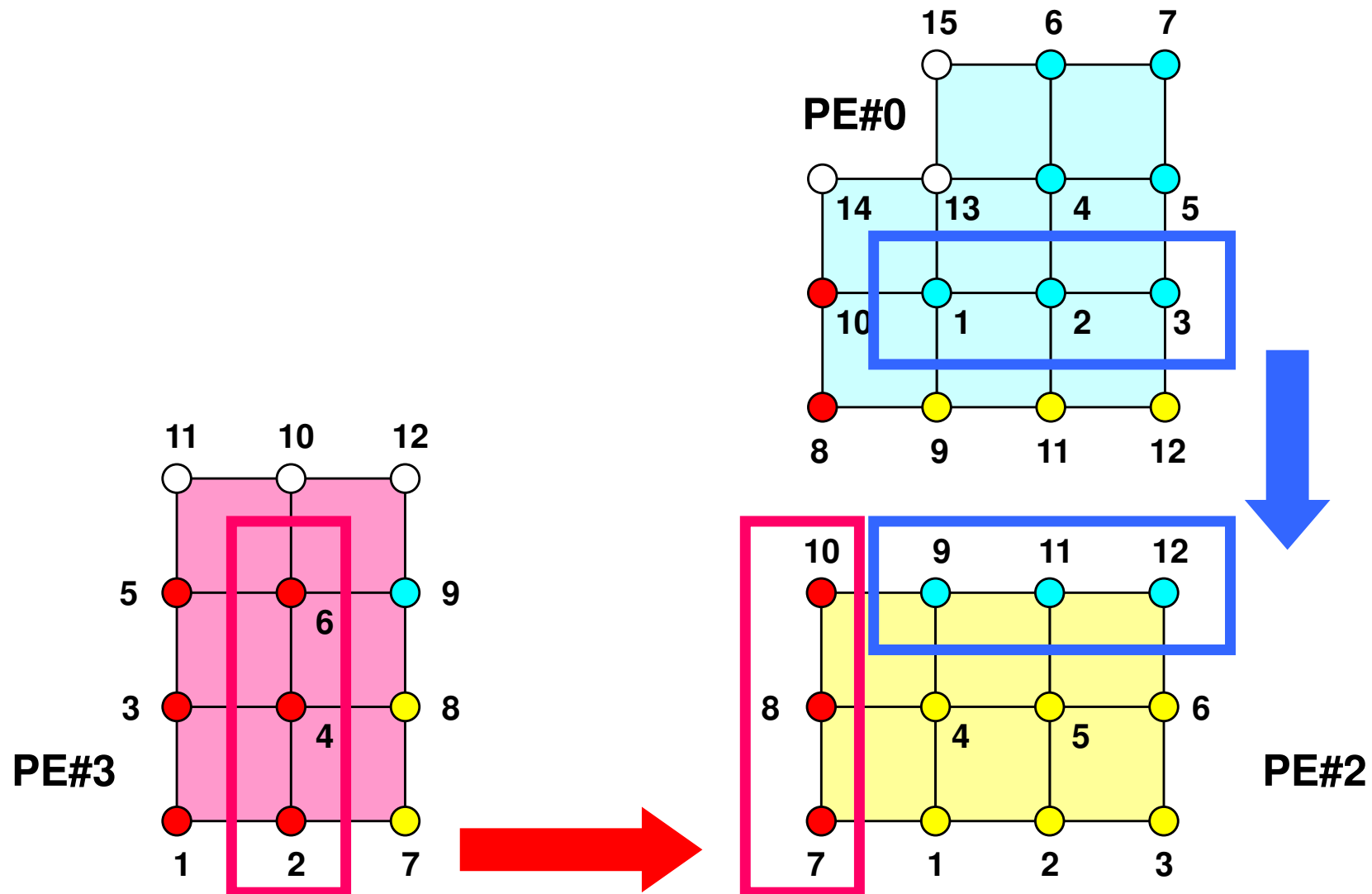

# PE-to-PE comm. : Local Data

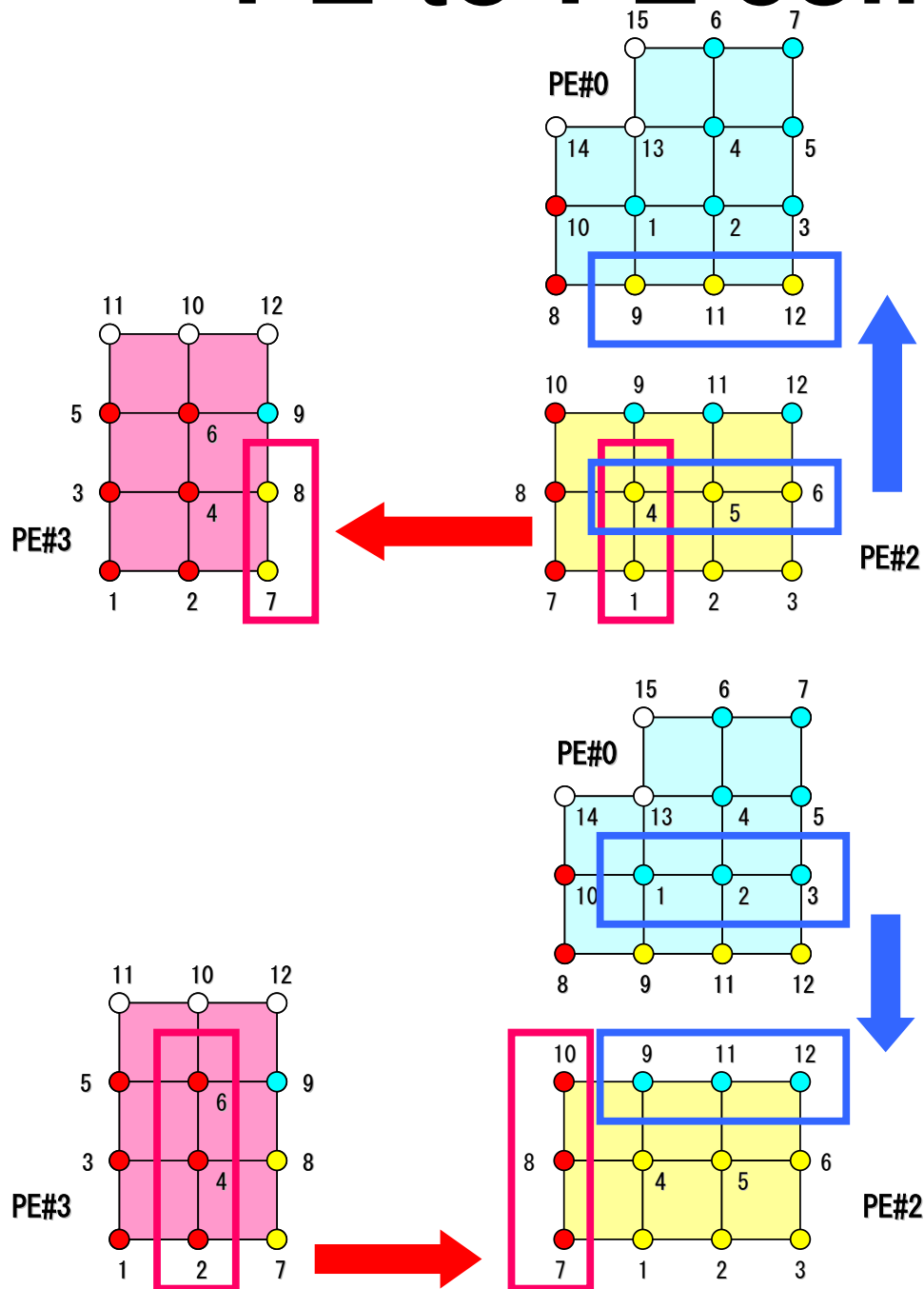

(中略)

2	
2	
3	0
3	6
7	
8	
10	
9	
11	
12	
2	5
1	
4	
4	
5	
6	



# PE-to-PE comm. : Local Data (F)

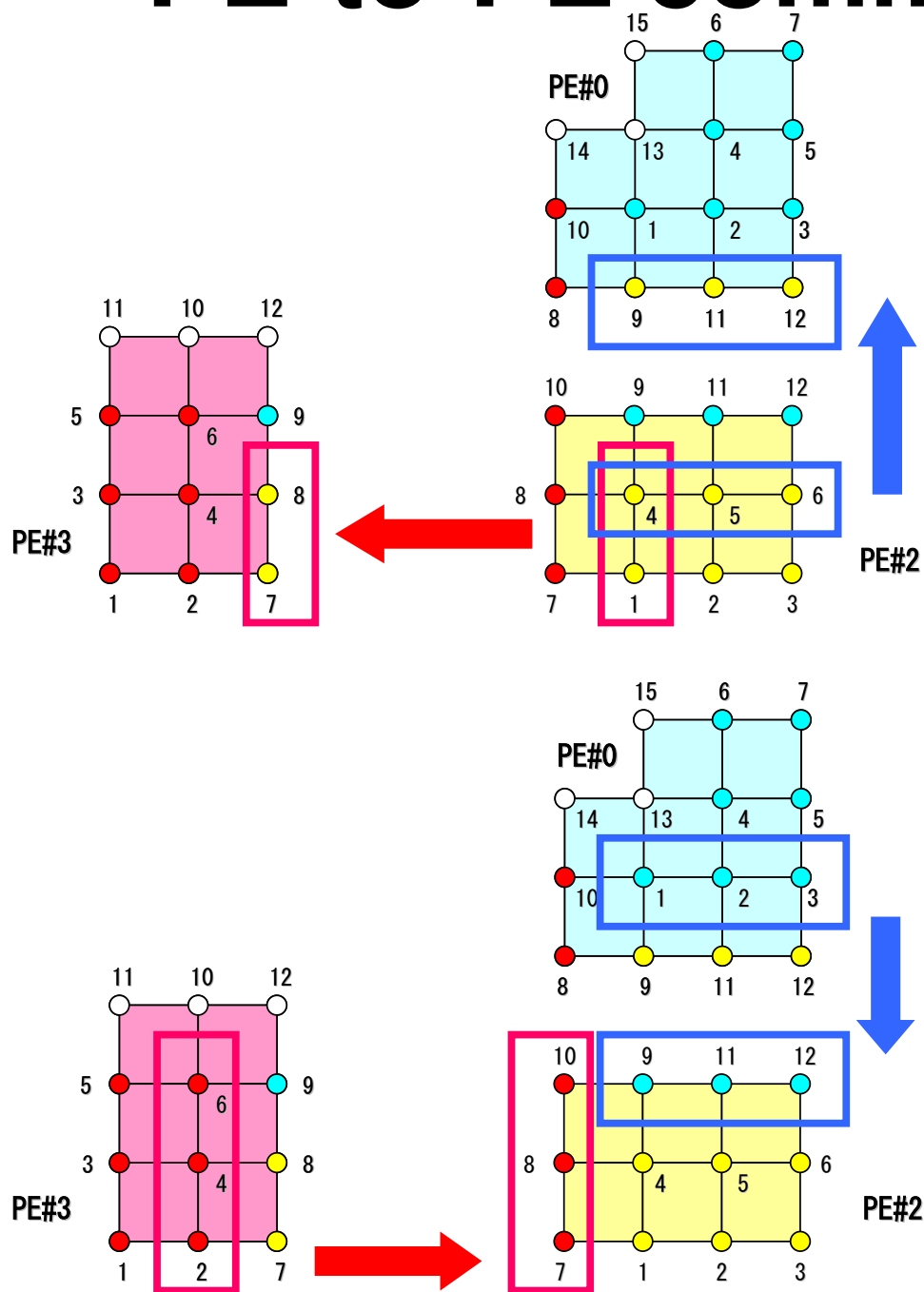

	2	ID of process
	2	Num. of Neighbors
	3	0
(中略)		ID of Neighbors
	3	6
	7	
	8	
	10	
	9	
	11	
	12	
	2	5
	1	
	4	
	4	
	5	
	6	

```

NEIBPETOT= 2
NEIBPE (1) =3, NEIBPE (2) = 0
    
```

# PE-to-PE comm. : SEND (F)

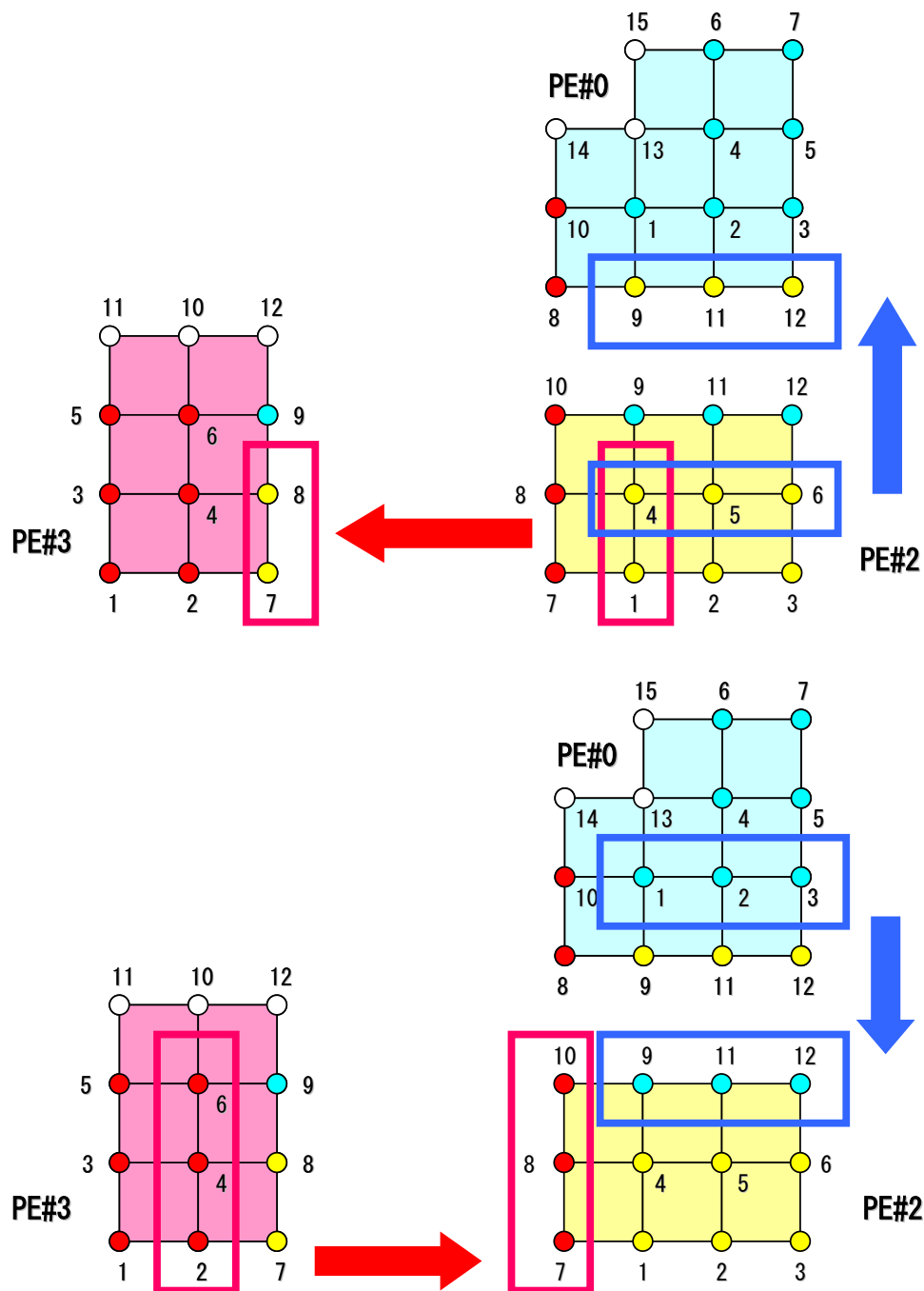

```

2
2
3
(中略)
3
7
8
10
9
11
12
2
1
4
4
5
6
5 export_index
    
```

```

export_index(0) = 0
export_index(1) = 2
export_index(2) = 2 + 3 = 5

export_item(1-5) = 1, 4, 4, 5, 6

Node "4" is sent to two processes (PE)
    
```

# PE-to-PE comm. : RECV (F)

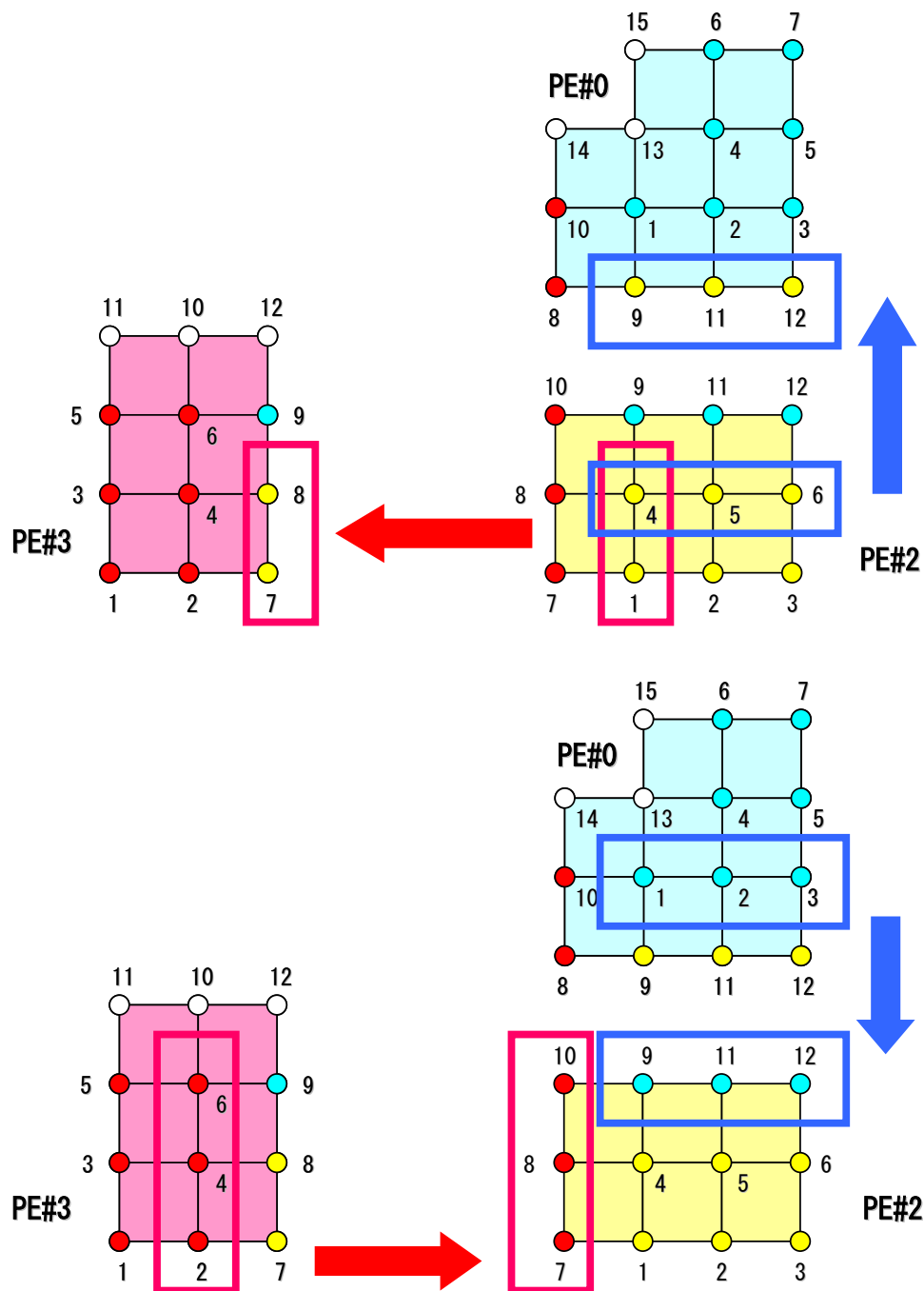

```

2
2
3
(中略)
3
7
8
10
9
11
12
2
1
4
4
5
6
0
6 import_index
5
    
```

```

import_index(0) = 0
import_index(1) = 3
import_index(2) = 3 + 3 = 6

import_item(1-6) = 7, 8, 10, 9, 11, 12
    
```

# Node Group

pc.0

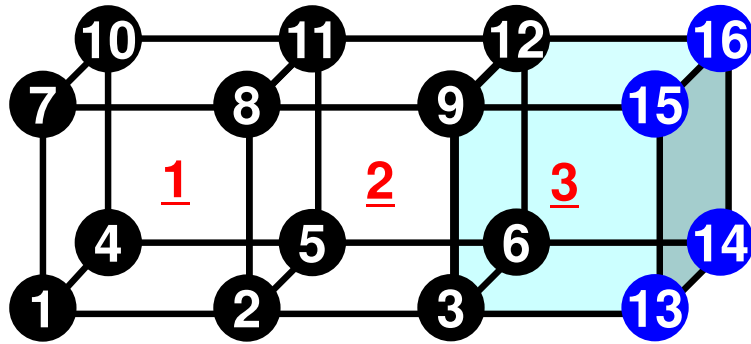

```

4
4 12 20 28
Xmin
1 4 7 10
Ymin
1 2 3 13 7 8 9 15
Zmin
1 2 3 13 4 5 6 14
Zmax
7 8 9 15 10 11 12 16

```

pc.1

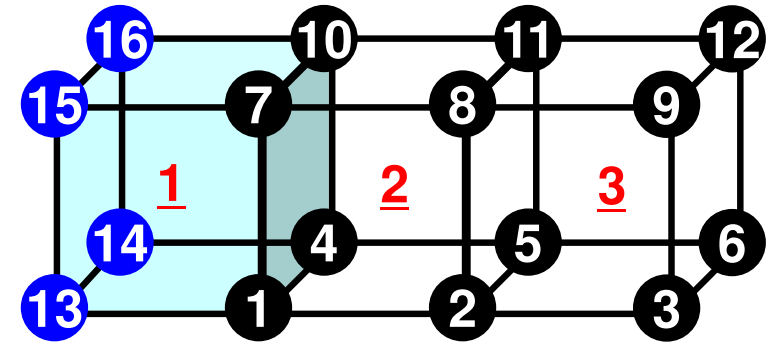

```

4
0 8 16 24
Xmin
Ymin
13 1 2 3 15 7 8 9
Zmin
13 1 2 3 14 4 5 6
Zmax
15 7 8 9 16 10 11 12

```

- pc.1

- Because there are node nodes which belong to “Xmin”, number of node is “0”.